

Accelerator Physics

Lecture 4

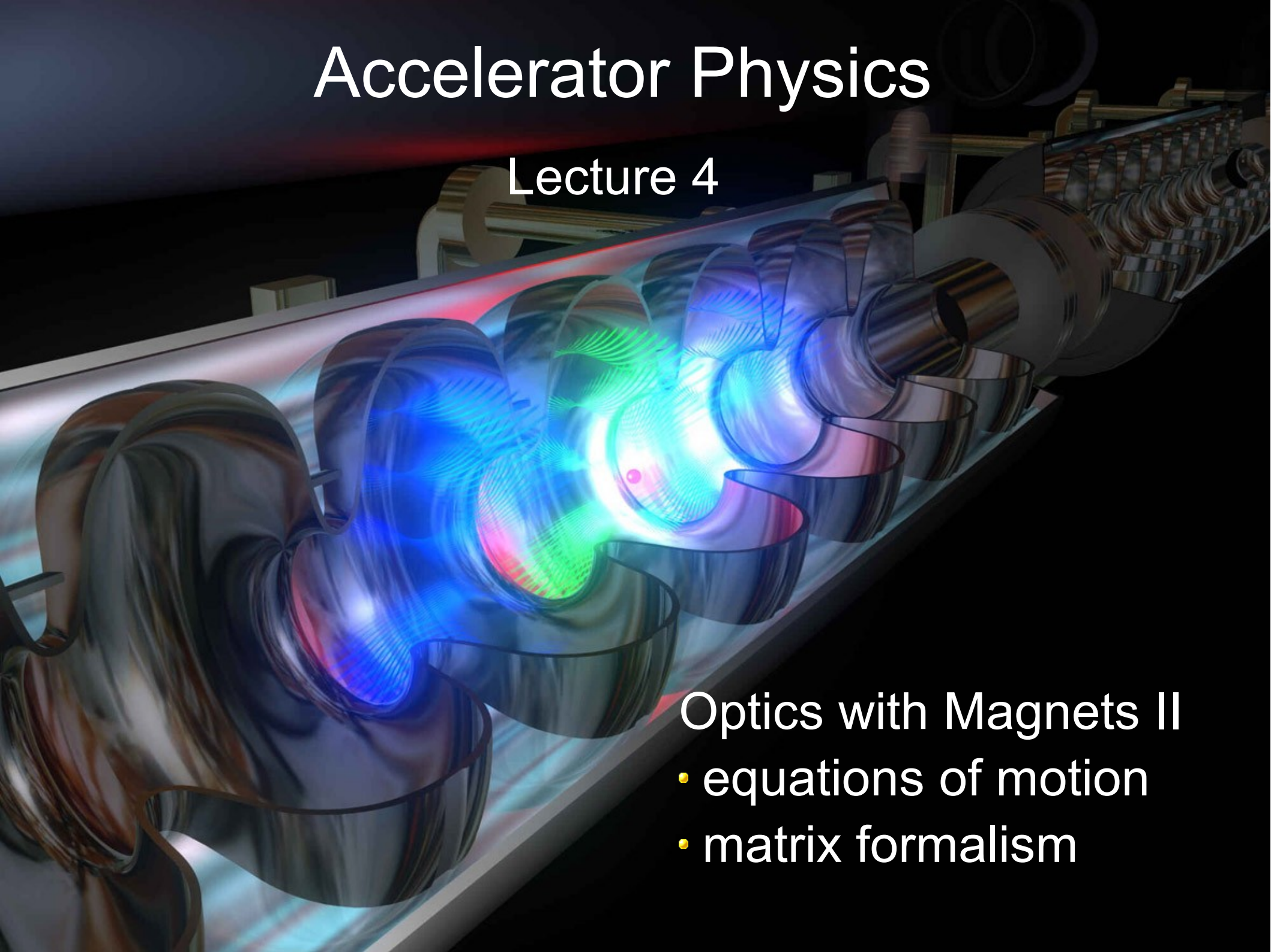

Optics with Magnets II

- equations of motion
- matrix formalism

Characteristic Solutions

$$x(s) = x_0 c(s) + x_0' s(s)$$

$$y(s) = y_0 c(s) + y_0' s(s)$$

horizontal plane

vertical plane

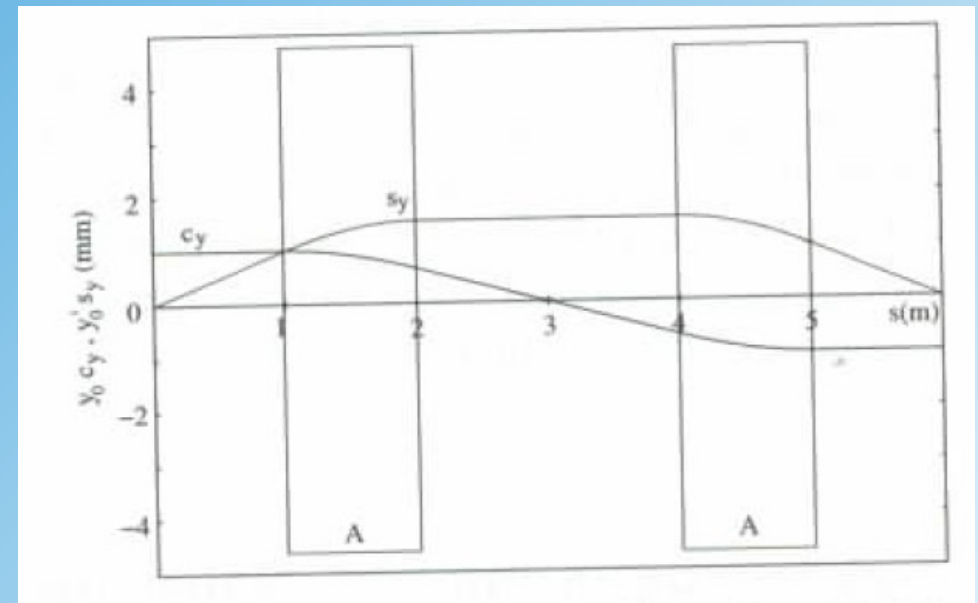
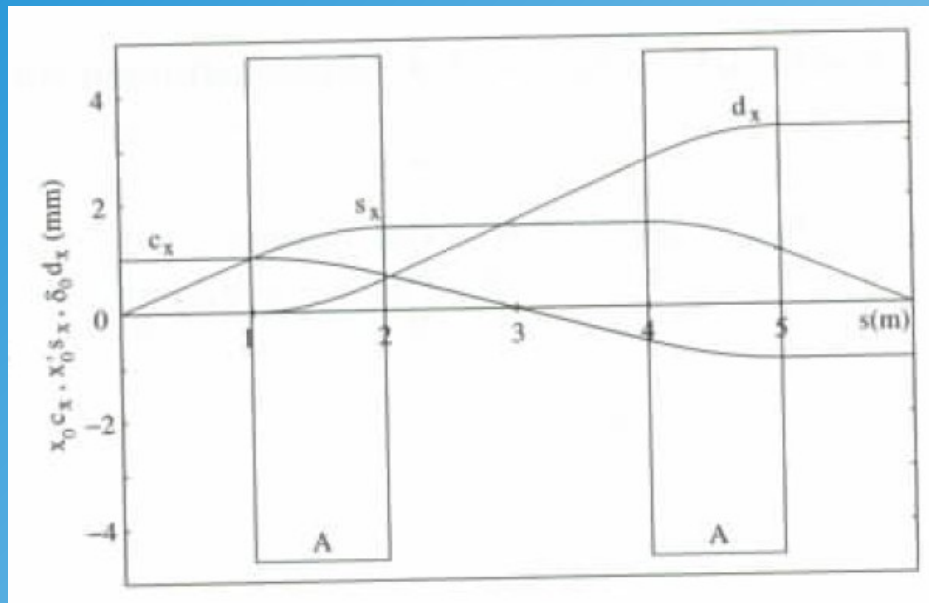

drift dipol drift dipol drift

drift dipol drift dipol drift

field index $n=0.5$

Transfer Matrix

(transfer matrix, transport matrix, R matrix)

$$R = \begin{pmatrix} (x|x) & (x|x') & 0 & 0 & 0 & (x|\delta) \\ (x'|x) & (x'|x') & 0 & 0 & 0 & (x'|\delta) \\ 0 & 0 & (y|y) & (y|y') & 0 & 0 \\ 0 & 0 & (y'|y) & (y'|y') & 0 & 0 \\ (l|x) & (l|x') & 0 & 0 & (l|l) & (l|\delta) \\ 0 & 0 & 0 & 0 & 0 & (\delta|\delta) \end{pmatrix}$$

Abbildung	radial	axial
Punkt-zu-Punkt	$R_{12} = (x x') = 0$	$R_{34} = (y y') = 0$
Punkt-zu-Parallel	$R_{22} = (x' x') = 0$	$R_{44} = (y' y') = 0$
Parallel-zu-Punkt	$R_{11} = (x x) = 0$	$R_{33} = (y y) = 0$
Parallel-zu-Parallel	$R_{21} = (x' x) = 0$	$R_{43} = (y' y) = 0$
Ortsdispersion = 0	$R_{16} = (x \delta) = 0$	
Winkeldispersion = 0	$R_{26} = (x' \delta) = 0$	

Drift

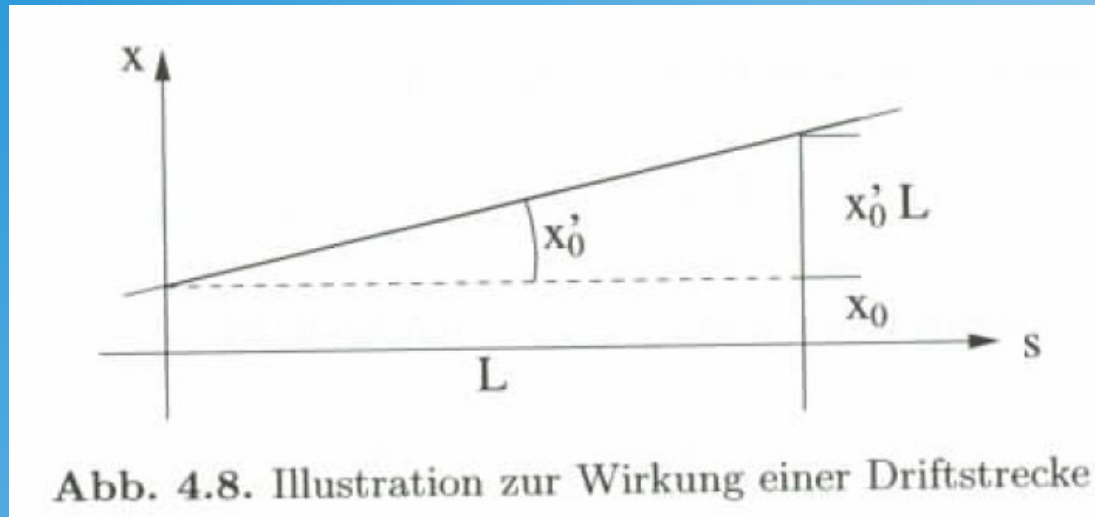

$$\begin{aligned}
 x &= x_0 + L x'_0 \\
 x' &= x'_0 \\
 y &= y_0 + L y'_0 \\
 y' &= y'_0 \\
 l &= l_0 + L/\gamma^2 \delta'_0 \\
 \delta' &= \delta'_0
 \end{aligned}$$

$$R = \begin{pmatrix} 1 & L & 0 & 0 & 0 & 0 \\ 0 & 1 & 0 & 0 & 0 & 0 \\ 0 & 0 & 1 & L & 0 & 0 \\ 0 & 0 & 0 & 1 & 0 & 0 \\ 0 & 0 & 0 & 0 & 1 & L/\gamma^2 \\ 0 & 0 & 0 & 0 & 0 & 1 \end{pmatrix} .$$

$$R = \begin{pmatrix} (x|x) & (x|x') & 0 & 0 & 0 & (x|\delta) \\ (x'|x) & (x'|x') & 0 & 0 & 0 & (x'|\delta) \\ 0 & 0 & (y|y) & (y|y') & 0 & 0 \\ 0 & 0 & (y'|y) & (y'|y') & 0 & 0 \\ (l|x) & (l|x') & 0 & 0 & (l|l) & (l|\delta) \\ 0 & 0 & 0 & 0 & 0 & (\delta|\delta) \end{pmatrix}$$

Quadrupoles

Quadrupol (radial fokussierend und axial defokussierend)

$$R = \begin{pmatrix} \cos \sqrt{k}L & \frac{\sin \sqrt{k}L}{\sqrt{k}} & 0 & 0 & 0 & 0 \\ -\sqrt{k} \sin \sqrt{k}L & \cos \sqrt{k}L & 0 & 0 & 0 & 0 \\ 0 & 0 & \cosh \sqrt{k}L & \frac{\sinh \sqrt{k}L}{\sqrt{k}} & 0 & 0 \\ 0 & 0 & \sqrt{k} \sinh \sqrt{k}L & \cosh \sqrt{k}L & 0 & 0 \\ 0 & 0 & 0 & 0 & 1 & \frac{L}{\gamma^2} \\ 0 & 0 & 0 & 0 & 0 & 1 \end{pmatrix},$$

$$g = \frac{\partial B_y}{\partial x} = \frac{\partial B_x}{\partial y}$$

$$k = \frac{|g|}{(B\rho_0)} = \frac{|B_0|}{a} \frac{1}{(B\rho_0)}$$

Quadrupol (radial defokussierend und axial fokussierend)

$$R = \begin{pmatrix} \cosh \sqrt{k}L & \frac{\sinh \sqrt{k}L}{\sqrt{k}} & 0 & 0 & 0 & 0 \\ \sqrt{k} \sinh \sqrt{k}L & \cosh \sqrt{k}L & 0 & 0 & 0 & 0 \\ 0 & 0 & \cos \sqrt{k}L & \frac{\sin \sqrt{k}L}{\sqrt{k}} & 0 & 0 \\ 0 & 0 & -\sqrt{k} \sin \sqrt{k}L & \cos \sqrt{k}L & 0 & 0 \\ 0 & 0 & 0 & 0 & 1 & \frac{L}{\gamma^2} \\ 0 & 0 & 0 & 0 & 0 & 1 \end{pmatrix}.$$

$$R = \begin{pmatrix} (x|x) & (x|x') & 0 & 0 & 0 & (x|\delta) \\ (x'|x) & (x'|x') & 0 & 0 & 0 & (x'|\delta) \\ 0 & 0 & (y|y) & (y|y') & 0 & 0 \\ 0 & 0 & (y'|y) & (y'|y') & 0 & 0 \\ (l|x) & (l|x') & 0 & 0 & (l|l) & (l|\delta) \\ 0 & 0 & 0 & 0 & 0 & (\delta|\delta) \end{pmatrix}$$

Dipole Magnet

$$k_x = \frac{1}{\rho_0^2}$$

$$k_y = 0$$

deflection angle:

$$\alpha = L / \rho_0$$

dispersion

Homogener Ablenkmagnet (Dipolmagnet, Sektormagnet)

$$R = \begin{pmatrix} \cos \alpha & \rho_0 \sin \alpha & 0 & 0 & 0 & \rho_0(1 - \cos \alpha) \\ -\frac{\sin \alpha}{\rho_0} & \cos \alpha & 0 & 0 & 0 & \sin \alpha \\ 0 & 0 & 1 & \rho_0 \alpha & 0 & 0 \\ 0 & 0 & 0 & 1 & 0 & 0 \\ -\sin \alpha & -\rho_0(1 - \cos \alpha) & 0 & 0 & 1 & \rho_0 \frac{\alpha}{\gamma^2} - \rho_0(\alpha - \sin \alpha) \\ 0 & 0 & 0 & 0 & 0 & 1 \end{pmatrix}$$

orbit effects

drift

$$R = \begin{pmatrix} (x|x) & (x|x') & 0 & 0 & 0 & (x|\delta) \\ (x'|x) & (x'|x') & 0 & 0 & 0 & (x'|\delta) \\ 0 & 0 & (y|y) & (y|y') & 0 & 0 \\ 0 & 0 & (y'|y) & (y'|y') & 0 & 0 \\ (l|x) & (l|x') & 0 & 0 & (l|l) & (l|\delta) \\ 0 & 0 & 0 & 0 & 0 & (\delta|\delta) \end{pmatrix}$$

Weakly Focussing Dipole

$$R = \begin{pmatrix} (x|x) & (x|x') & 0 & 0 & 0 & (x|\delta) \\ (x'|x) & (x'|x') & 0 & 0 & 0 & (x'|\delta) \\ 0 & 0 & (y|y) & (y|y') & 0 & 0 \\ 0 & 0 & (y'|y) & (y'|y') & 0 & 0 \\ (l|x) & (l|x') & 0 & 0 & (l|l) & (l|\delta) \\ 0 & 0 & 0 & 0 & 0 & (\delta|\delta) \end{pmatrix}$$

weakly focussing $0 < n < 1$

$$k_x = \frac{1-n}{\rho_0^2} \quad k_y = \frac{n}{\rho^2}$$

deflection angle:
 $\alpha = L / \rho_0$

focussing in both planes
(x-y)

Schwach fokussierender Ablenkmagnet ($0 < n < 1$)

$$R_x = \begin{pmatrix} \cos \sqrt{1-n}\alpha & \frac{\rho_0 \sin \sqrt{1-n}\alpha}{\sqrt{1-n}} & \frac{\rho_0(1-\cos \sqrt{1-n}\alpha)}{1-n} \\ -\frac{\sqrt{1-n} \sin \sqrt{1-n}\alpha}{\rho_0} & \cos \sqrt{1-n}\alpha & \frac{\sin \sqrt{1-n}\alpha}{\sqrt{1-n}} \\ 0 & 0 & 1 \end{pmatrix}$$

$$R_y = \begin{pmatrix} \cos \sqrt{n}\alpha & \frac{\rho_0 \sin \sqrt{n}\alpha}{\sqrt{n}} \\ -\frac{\sqrt{n} \sin \sqrt{n}\alpha}{\rho_0} & \cos \sqrt{n}\alpha \end{pmatrix}.$$

Strongly Focussing Dipole

$$R = \begin{pmatrix} (x|x) & (x|x') & 0 & 0 & 0 & (x|\delta) \\ (x'|x) & (x'|x') & 0 & 0 & 0 & (x'|\delta) \\ 0 & 0 & (y|y) & (y|y') & 0 & 0 \\ 0 & 0 & (y'|y) & (y'|y') & 0 & 0 \\ (l|x) & (l|x') & 0 & 0 & (l|l) & (l|\delta) \\ 0 & 0 & 0 & 0 & 0 & (\delta|\delta) \end{pmatrix}$$

strongly focussing

defocussing

Stark fokussierender Ablenkmagnet ($n < 0$)

$$R_x = \begin{pmatrix} \cos \sqrt{1-n}\alpha & \frac{\rho_0 \sin \sqrt{1-n}\alpha}{\sqrt{1-n}} & \frac{\rho_0(1-\cos \sqrt{1-n}\alpha)}{1-n} \\ -\frac{\sqrt{1-n} \sin \sqrt{1-n}\alpha}{\rho_0} & \cos \sqrt{1-n}\alpha & \frac{\sin \sqrt{1-n}\alpha}{\sqrt{1-n}} \\ 0 & 0 & 1 \end{pmatrix}$$

$$R_y = \begin{pmatrix} \cosh \sqrt{|n|}\alpha & \frac{\rho_0 \sinh \sqrt{|n|}\alpha}{\sqrt{|n|}} \\ \frac{\sqrt{|n|} \sinh \sqrt{|n|}\alpha}{\rho_0} & \cosh \sqrt{|n|}\alpha \end{pmatrix}.$$

strongly focussing

defocussing

Stark fokussierender Ablenkmagnet ($n > 1$)

$$R_x = \begin{pmatrix} \cosh \sqrt{|1-n|}\alpha & \frac{\rho_0 \sinh \sqrt{|1-n|}\alpha}{\sqrt{|1-n|}} & \frac{\rho_0(1-\cosh \sqrt{|1-n|}\alpha)}{1-n} \\ \frac{\sqrt{|1-n|} \sinh \sqrt{|1-n|}\alpha}{\rho_0} & \cosh \sqrt{|1-n|}\alpha & \frac{\sinh \sqrt{|1-n|}\alpha}{\sqrt{|1-n|}} \\ 0 & 0 & 1 \end{pmatrix},$$

$$R_y = \begin{pmatrix} \cos \sqrt{n}\alpha & \frac{\rho_0 \sin \sqrt{n}\alpha}{\sqrt{n}} \\ -\frac{\sqrt{n} \sin \sqrt{n}\alpha}{\rho_0} & \cos \sqrt{n}\alpha \end{pmatrix}.$$

Edge Focussing

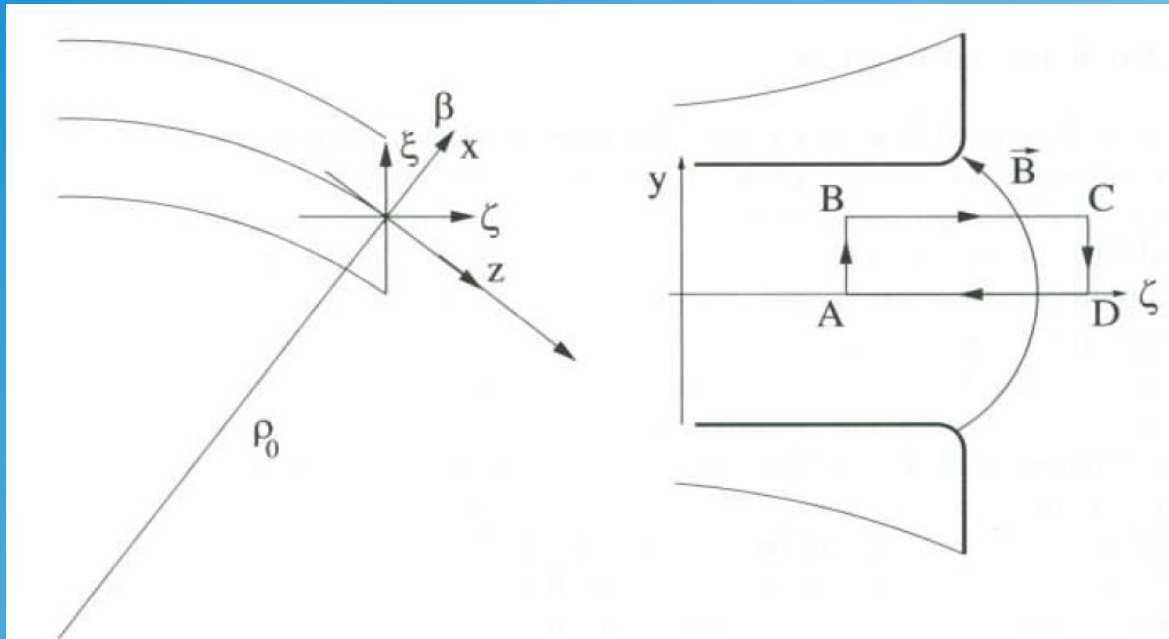

for calculation
see Hinterberger

$$R = \begin{pmatrix} (x|x) & (x|x') & 0 & 0 & 0 & (x|\delta) \\ (x'|x) & (x'|x') & 0 & 0 & 0 & (x'|\delta) \\ 0 & 0 & (y|y) & (y|y') & 0 & 0 \\ 0 & 0 & (y'|y) & (y'|y') & 0 & 0 \\ (l|x) & (l|x') & 0 & 0 & (l|l) & (l|\delta) \\ 0 & 0 & 0 & 0 & 0 & (\delta|\delta) \end{pmatrix}$$

Kantenfokussierung

$$R = \begin{pmatrix} 1 & 0 & 0 & 0 & 0 & 0 \\ \frac{\tan \beta}{\rho_0} & 1 & 0 & 0 & 0 & 0 \\ 0 & 0 & 1 & 0 & 0 & 0 \\ 0 & 0 & -\frac{\tan \beta_{\text{eff}}}{\rho_0} & 1 & 0 & 0 \\ 0 & 0 & 0 & 0 & 1 & 0 \\ 0 & 0 & 0 & 0 & 0 & 1 \end{pmatrix}$$

Rotations

Rotation um den Winkel α

$$R(\alpha) = \begin{pmatrix} \cos \alpha & 0 & \sin \alpha & 0 & 0 & 0 \\ 0 & \cos \alpha & 0 & \sin \alpha & 0 & 0 \\ -\sin \alpha & 0 & \cos \alpha & 0 & 0 & 0 \\ 0 & -\sin \alpha & 0 & \cos \alpha & 0 & 0 \\ 0 & 0 & 0 & 0 & 1 & 0 \\ 0 & 0 & 0 & 0 & 0 & 1 \end{pmatrix}$$

$$R = \begin{pmatrix} (x|x) & (x|x') & 0 & 0 & 0 & (x|\delta) \\ (x'|x) & (x'|x') & 0 & 0 & 0 & (x'|\delta) \\ 0 & 0 & (y|y) & (y|y') & 0 & 0 \\ 0 & 0 & (y'|y) & (y'|y') & 0 & 0 \\ (l|x) & (l|x') & 0 & 0 & (l|l) & (l|\delta) \\ 0 & 0 & 0 & 0 & 0 & (\delta|\delta) \end{pmatrix}$$

Solenoid I

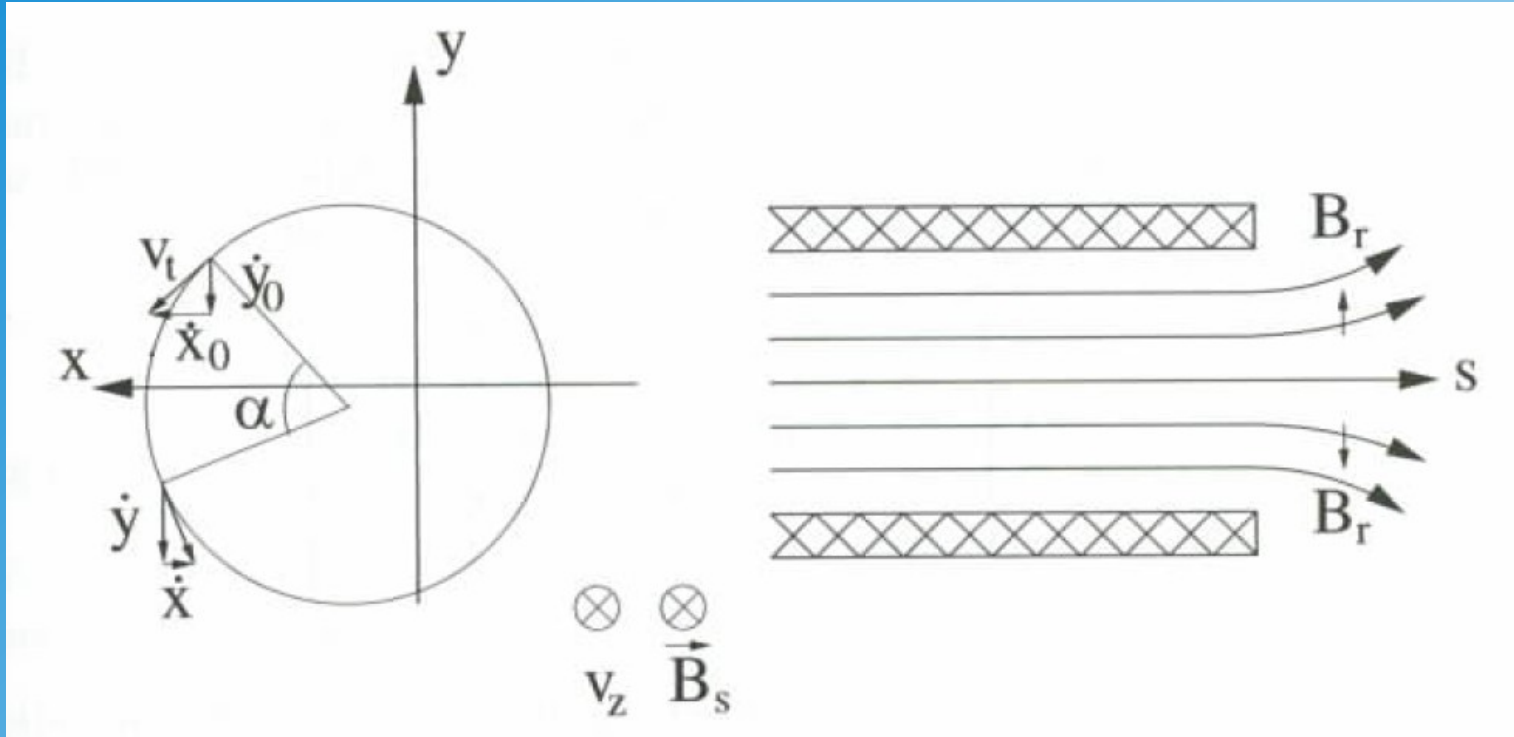

$$R = \begin{pmatrix} (x|x) & (x|x') & 0 & 0 & 0 & (x|\delta) \\ (x'|x) & (x'|x') & 0 & 0 & 0 & (x'|\delta) \\ 0 & 0 & (y|y) & (y|y') & 0 & 0 \\ 0 & 0 & (y'|y) & (y'|y') & 0 & 0 \\ (l|x) & (l|x') & 0 & 0 & (l|l) & (l|\delta) \\ 0 & 0 & 0 & 0 & 0 & (\delta|\delta) \end{pmatrix}$$

Solenoid II

transfer matrix

$$R = \begin{pmatrix} C^2 & SC/K & SC & S^2/K & 0 & 0 \\ -KSC & C^2 & -KS^2 & SC & 0 & 0 \\ -SC & -S^2/K & C^2 & SC/K & 0 & 0 \\ KS^2 & -SC & -KSC & C^2 & 0 & 0 \\ 0 & 0 & 0 & 0 & 1 & L/\gamma^2 \\ 0 & 0 & 0 & 0 & 0 & 1 \end{pmatrix}.$$

$$\alpha = -2 KL$$

$$C = \cos(KL)$$

$$S = \sin(KL)$$

$$K = B_s / 2 / (B\rho)_0$$

transfer matrix without rotation

$$R(\alpha/2)R = \begin{pmatrix} C & S/K & 0 & 0 & 0 & 0 \\ -KS & C & 0 & 0 & 0 & 0 \\ 0 & 0 & C & S/K & 0 & 0 \\ 0 & 0 & -KS & C & 0 & 0 \\ 0 & 0 & 0 & 0 & 1 & L/\gamma^2 \\ 0 & 0 & 0 & 0 & 0 & 1 \end{pmatrix}$$

Geometrical Optics I

(de-)focussing elements represented by lenses

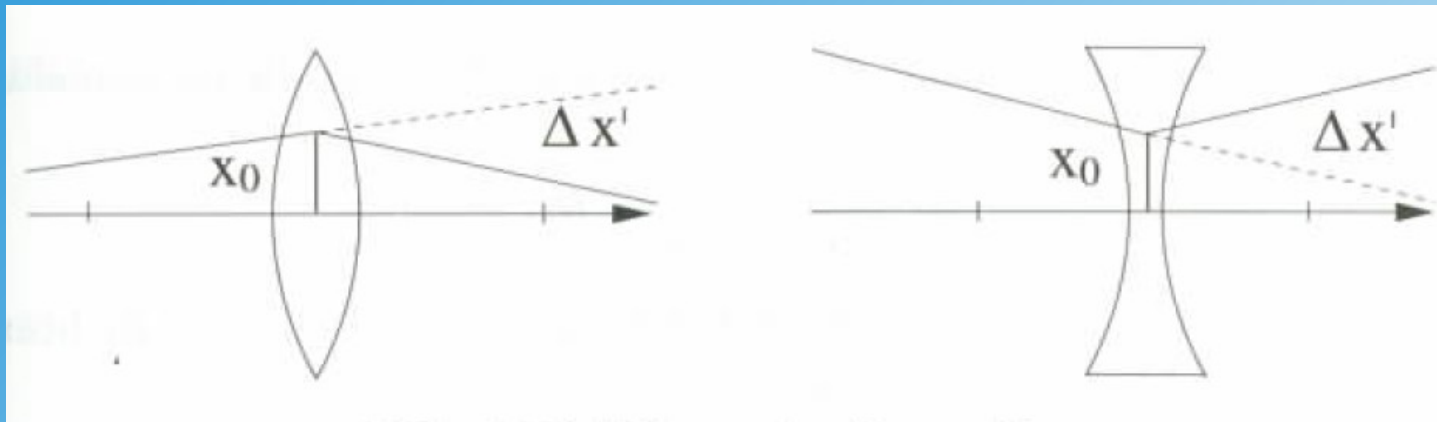

Geometrical Optics II

ideal lens

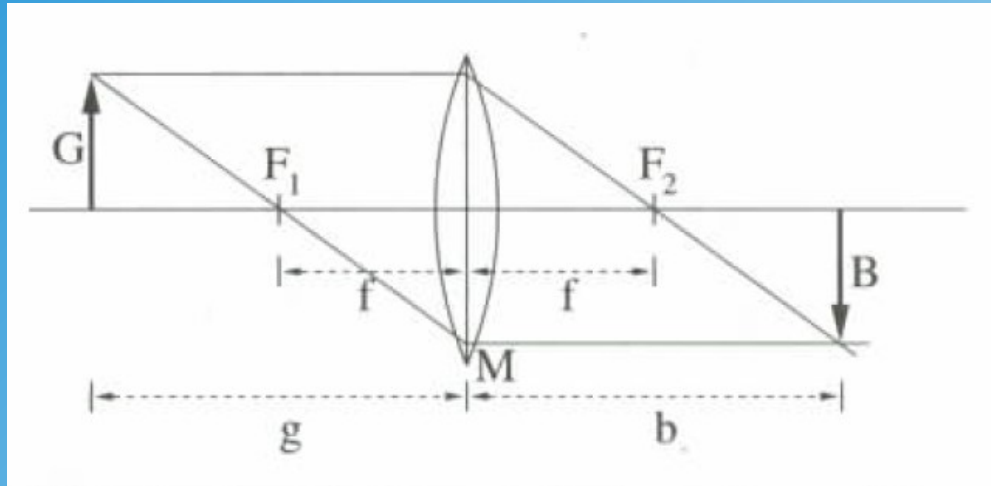

real lense

