



Particle Detectors with Arduino-based Frontend Electronics



Innovative Particle Detection

an Open-Hardware platform

- low-cost electronics
- kHz signal processing
- for students or rapid prototyping

¹ Physikalisches Institut Heidelberg University

² Physikalisches Institut University of Bonn

Markus Köhli^{1,2}, Fabian P. Schmidt², Jannis Weimar¹, Fabian Allmendinger¹, Jochen Kaminski², Klaus Desch², Ulrich Schmidt¹

With the Arduino open source electronics platform microcontrollers have become a comparably easy-to-use tool for rapid prototyping and implementing creative solutions. Their stability especially qualifies them to be used for slow control units. Yet, running at 16 MHz, the capabilities can be extended to data taking and signal analysis at decent rates. Such devices in combination with dedicated frontend electronics can offer low cost alternatives for student projects and independently operating small scale instrumentation. We present two projects, which cover as well the readout of helium-3 and boron-10 proportional counters as of scintillators or wavelength shifting fibers with Silicon Photomultipliers.

The nCatcher combines commercially available analog electronics and the Arduino nano enabling pulse shape analysis for proportional counters. The frontend integrates and shapes pulses to microseconds in order to use the Arduino's signal analysis capabilities - time over threshold measurement and a 10-bit analog to digital converter. Combining these two parameters allows for effective discrimination between different radiation types by estimating the total deposited energy (E) of incoming radiation as well as the mean energy loss per distance (dE/dx). This makes the device suitable for low to medium rate environments, where a good signal to noise ratio is a crucial.

With the SiPMTrigger we have realized a small scale design for triggering or vetoing. It consists of a custom mixed signal frontend board featuring signal amplification, discrimination and a coincidence unit. An Arduino MEGA digitally adjusts the thresholds of both channels and measures the trigger rate up to 200 kHz.

Proportional Counter

It's a Pulse Height Analyzer:

Designed to read out proportional chambers

- Integrating Pre-amplifier + Main-amplifier
- Comparator (Schmitt-Trigger)
- Arduino nano
- Pulse length and height measurements via time over threshold and internal 10-bit ADC
- Schmitt-Trigger threshold via 12-bit DAC

It's a Single Channel Analyzer:

- Comparator triggers nano's Input Capture Unit (ICU) if a pulse > a THL voltage
- The ICU measures the time for which the THL voltage is exceeded (Pulse-length)
- The ICU also triggers the ADC which needs between 250 ns and 16 μ s to sample the pulse height

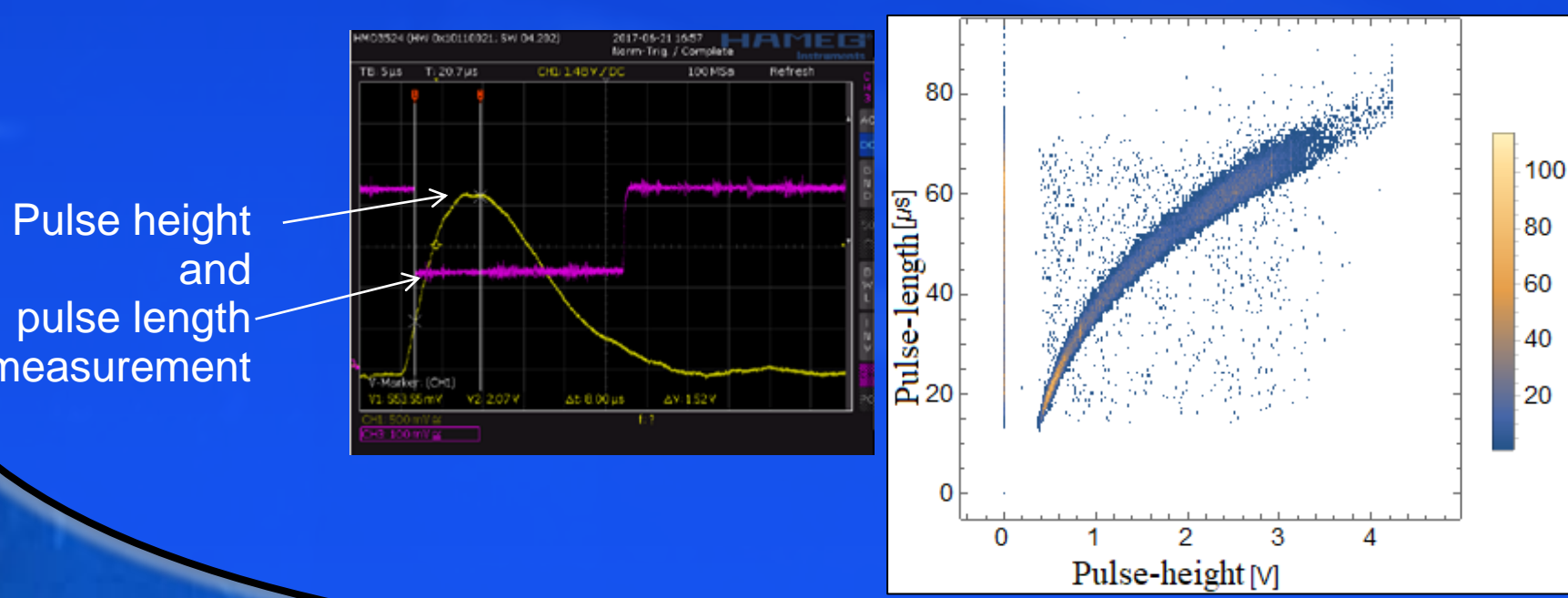
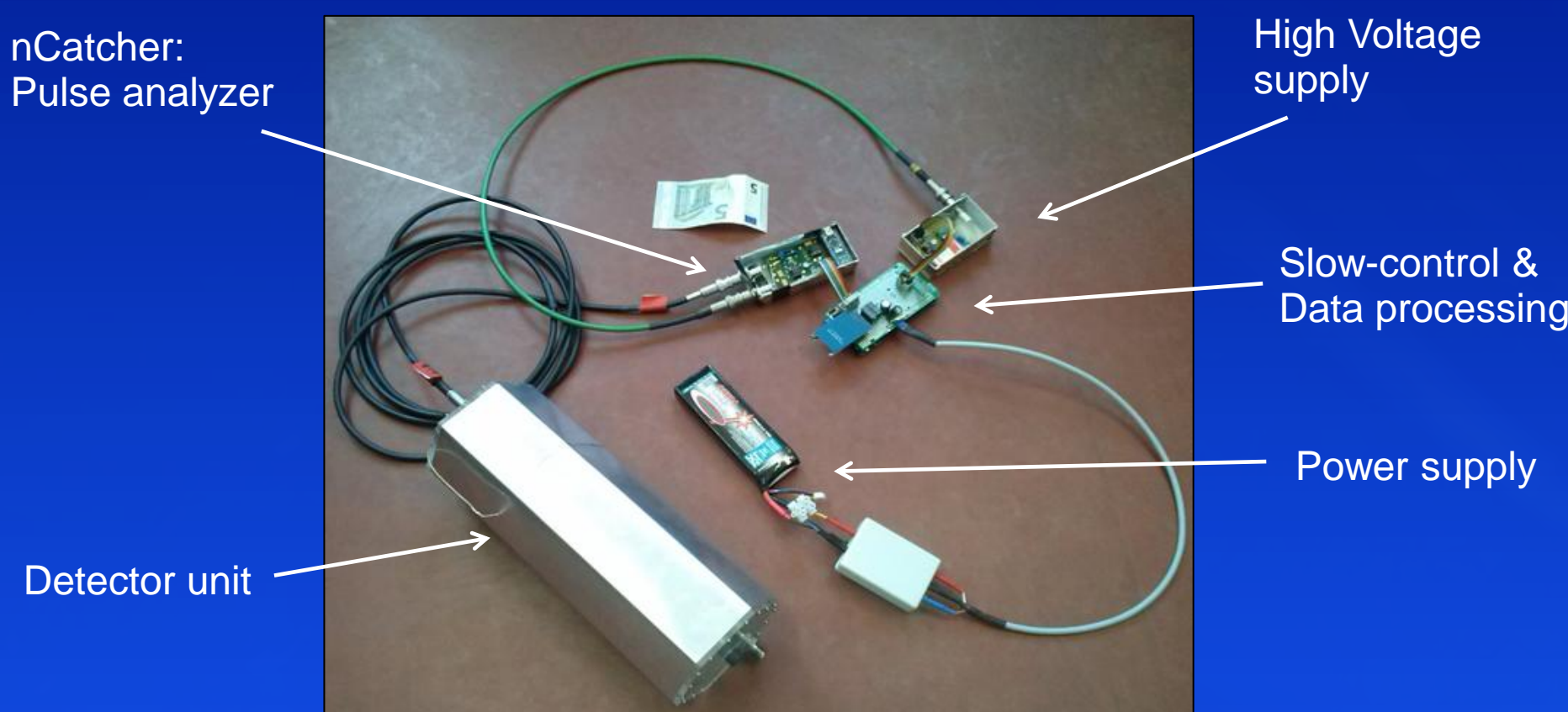

The Arduino Platform

	Arduino Uno	Arduino Mega	Arduino Nano
Microcontroller	ATmega328	ATmega2560	ATmega328
Flash Memory	32KB	256KB	32KB
Clock Speed	16MHz	16MHz	16 MHz
RAM	2KB	8KB	1KB
Price	15 €	19 €	6 €
Digital I/O Pins	14	54	14

Cost Calculation

Main Components:

- PCB: ~20 €
- PCB Components: ~15 €
- Arduino Nano: ~10 €
- Arduino MEGA: ~19 €
- Arduino Box: ~10 €

Optional:

- Coaxial Cable/Jacks: ~30 €
- SD Card and RTC: ~25 €
- DC-DC Converter: ~15€
- High Voltage Unit: ~150 €

Cost Calculation

Main Components:

- PCB: ~20 €
- PCB Components: ~28 €
- Arduino Nano: ~10 €
- Arduino Box: ~10 €
- SiPM (x2): ~80 €

Optional:

- Coaxial Cable/Jacks: ~30 €
- SD Card and RTC: ~25 €
- DC-DC Converter: ~15 €
- SiPM Voltage Unit: ~70 €

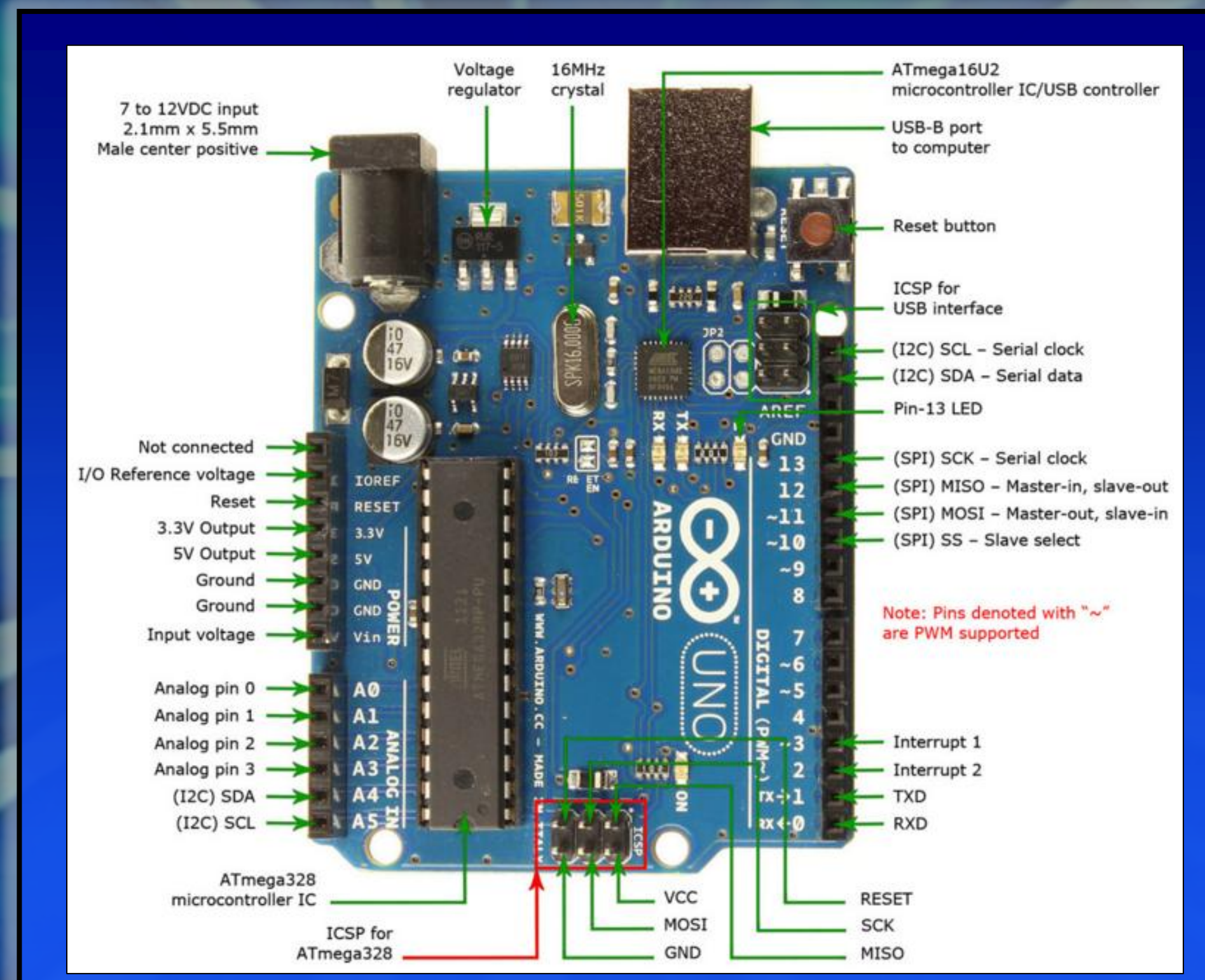

Scintillation Trigger

It's a Single Channel Analyzer:

Designed to read out Silicon Photomultipliers

- Pre-amplifier (x2)
- Digital Comparator (x2)
- Arduino MEGA for
- threshold adjustment (both channels)
- trigger rate measurement
- fast trigger output (<15 ns)

It's a Coincidence Counter:

- Comparator triggers Arduino if pulse height > THL voltage
- a discrete logic gate provides the fast coincidence signal of both channels
- external coincidence for chaining
- The full coincidence pulse height spectrum can be obtained by a THL Scan

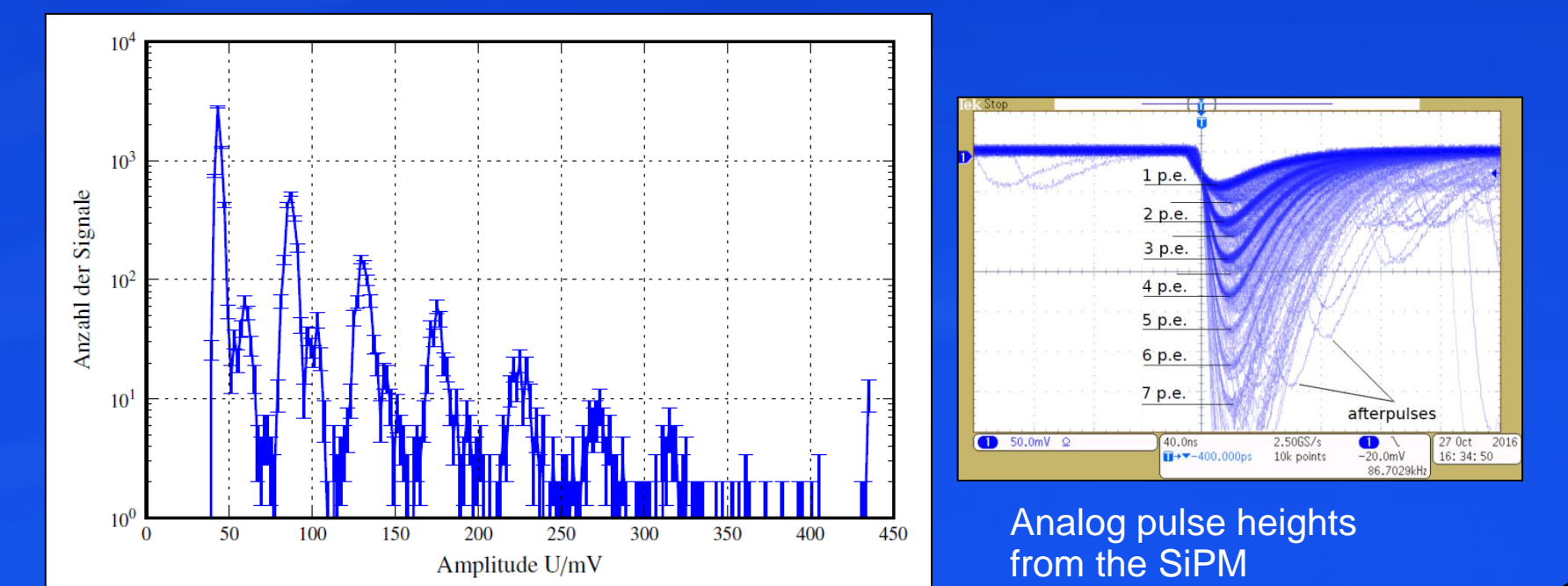
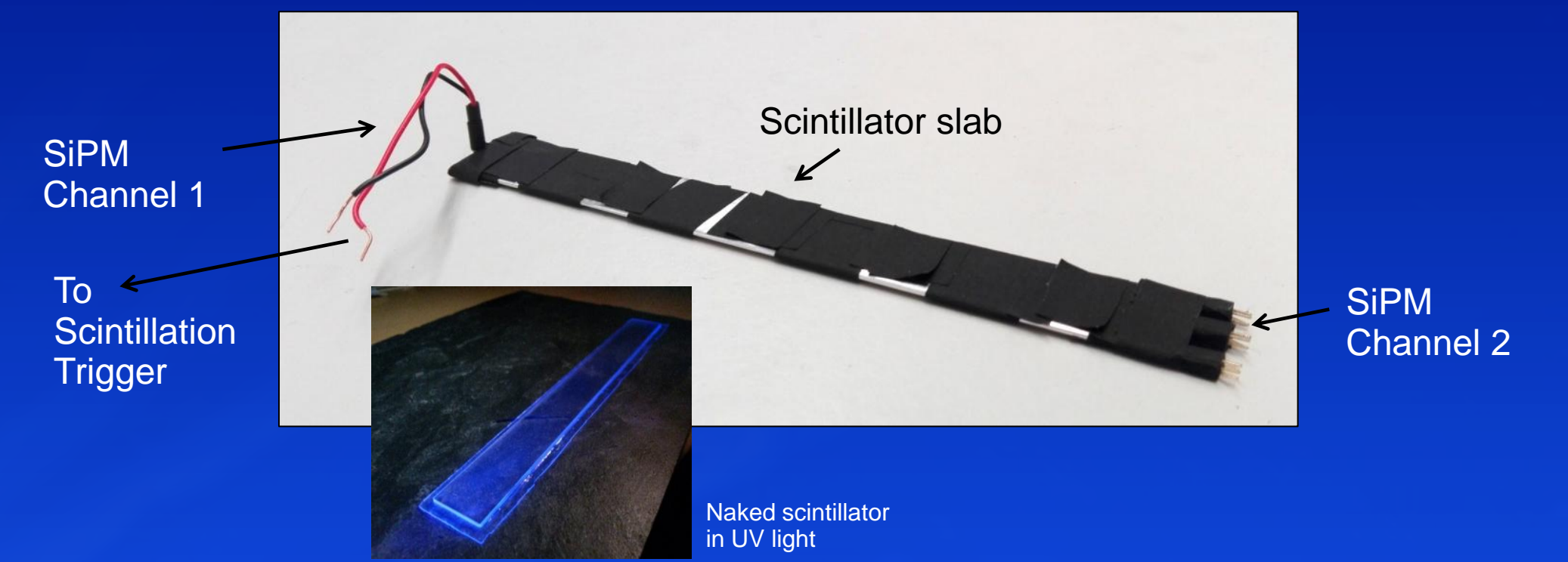

Electronics

Read-out unit (Pulse Analyzer)

Analog read-out and amplification via commercially available operational amplifiers

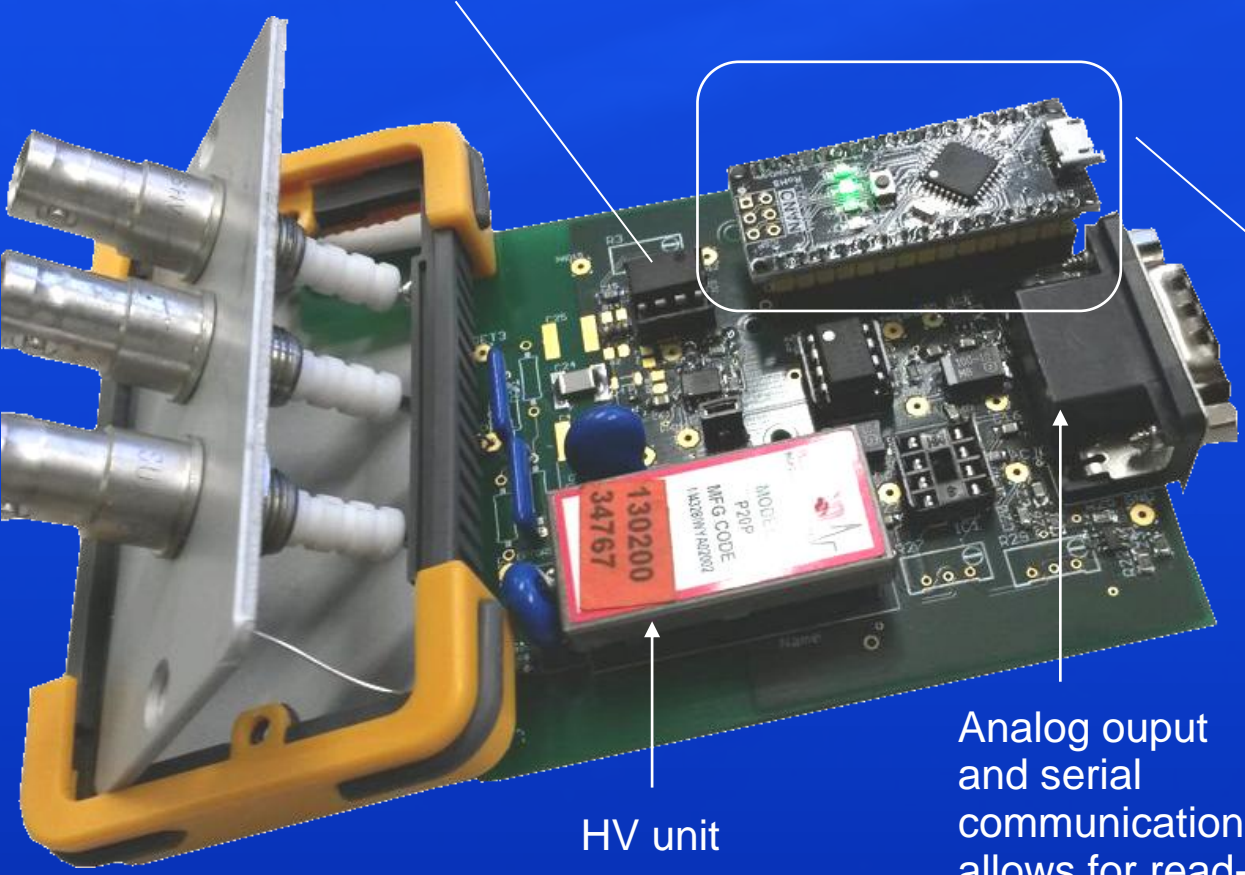

- ADC: pulse height measurement
- Time over threshold: pulse length measurement
- Communication with data loggers possible via PC

Analog output and serial communication allows for read-out and control

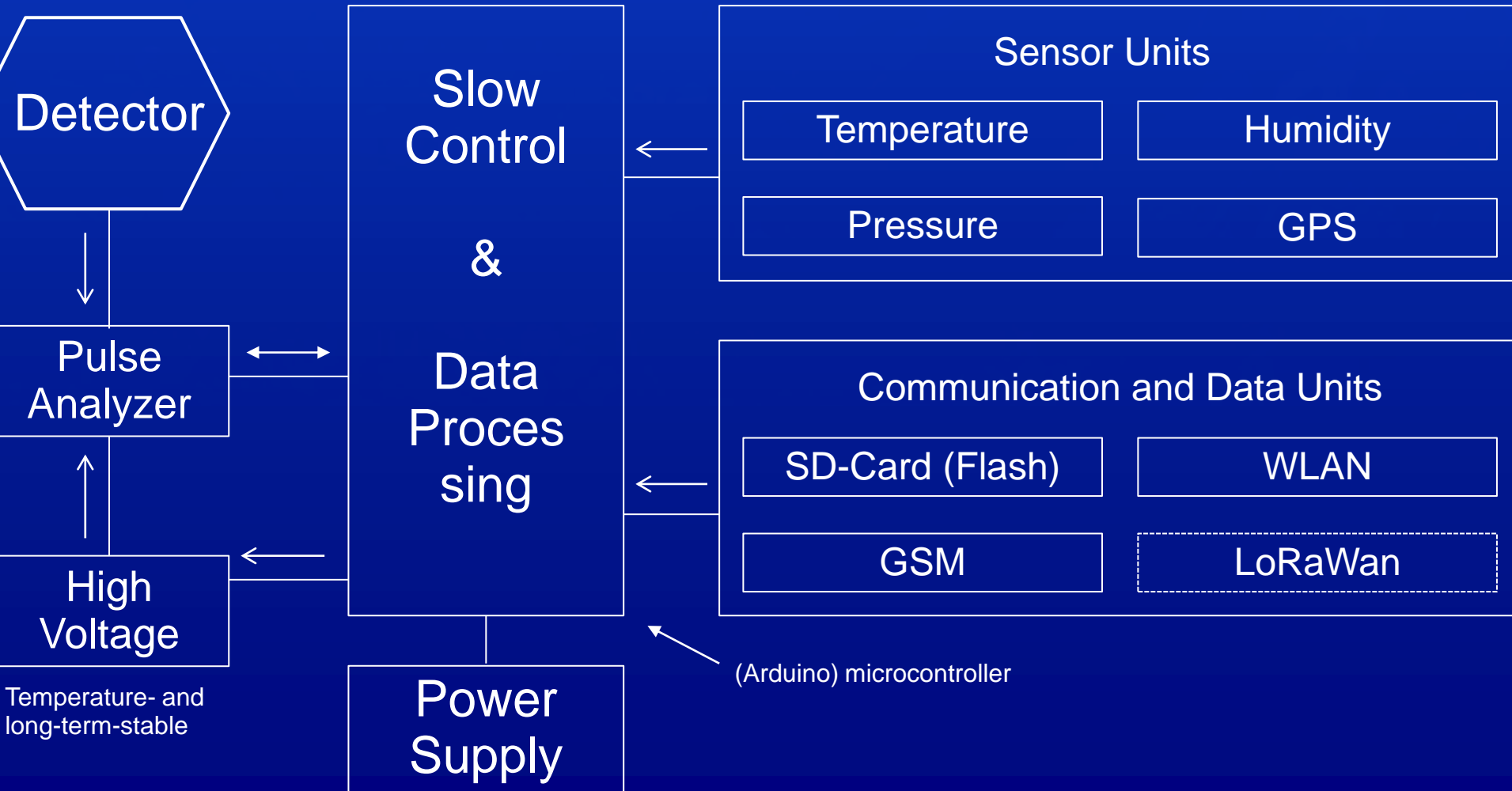

Arduino Studio

Usability for education: easy programming interface

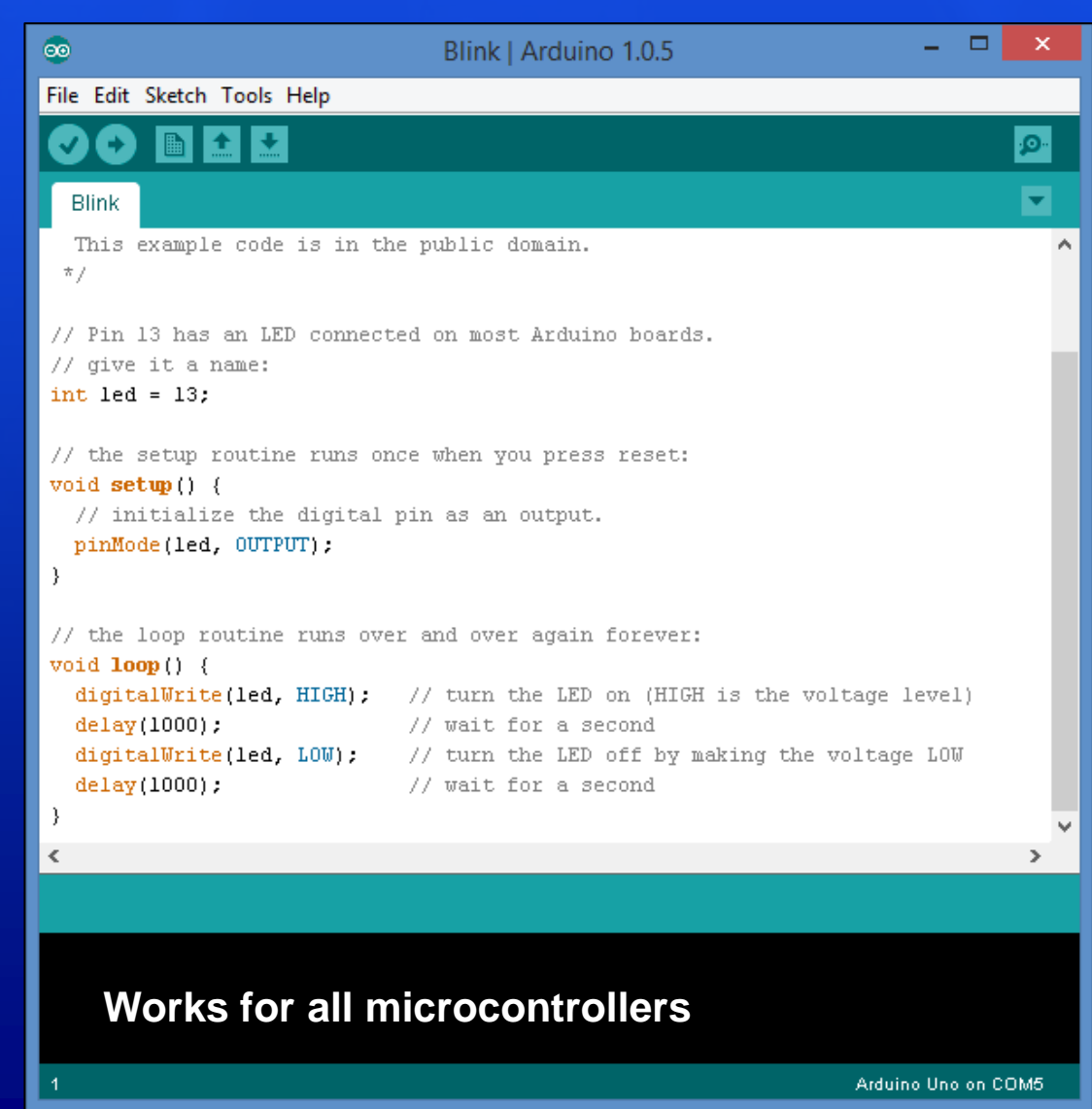

Electronics

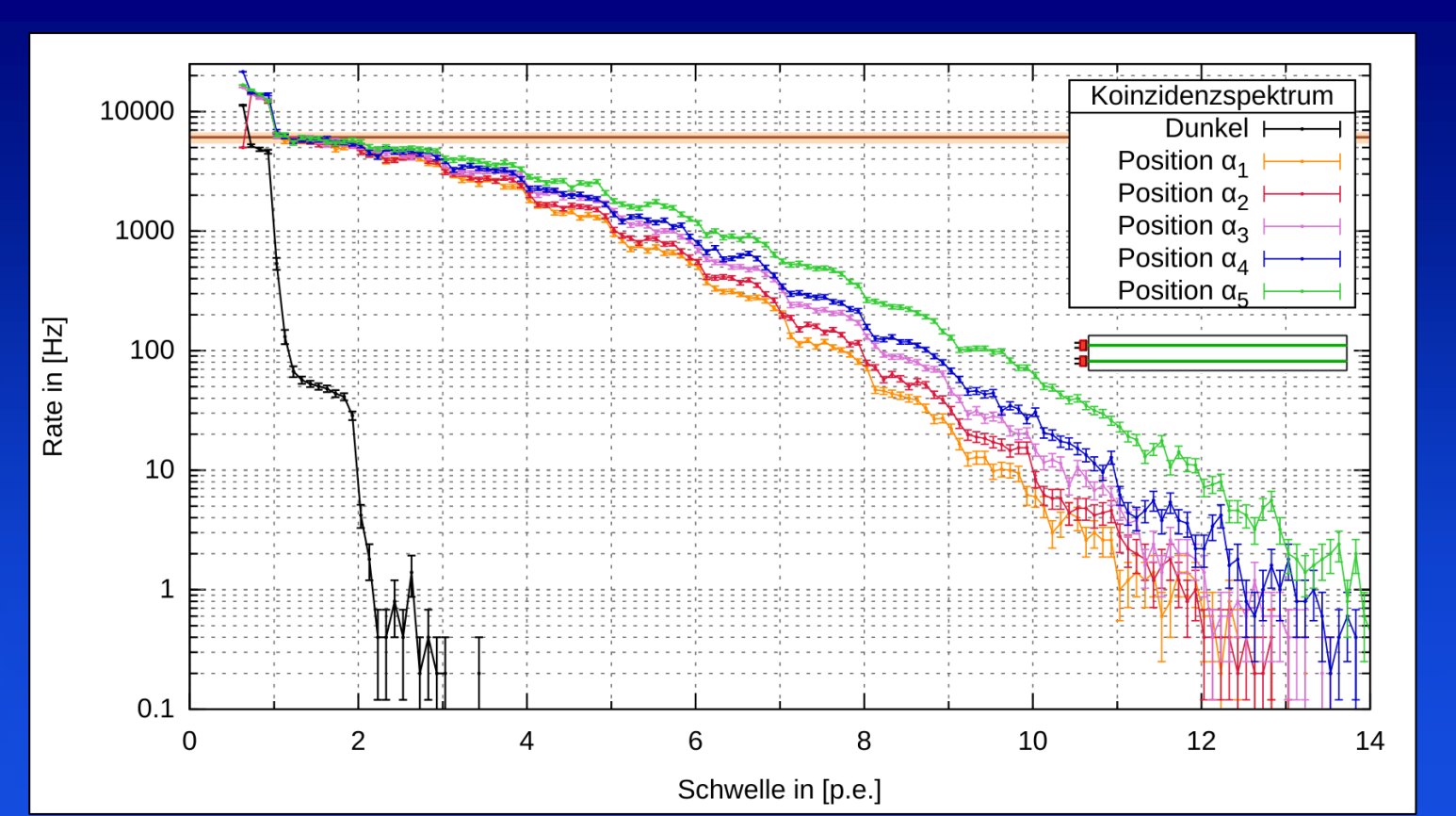
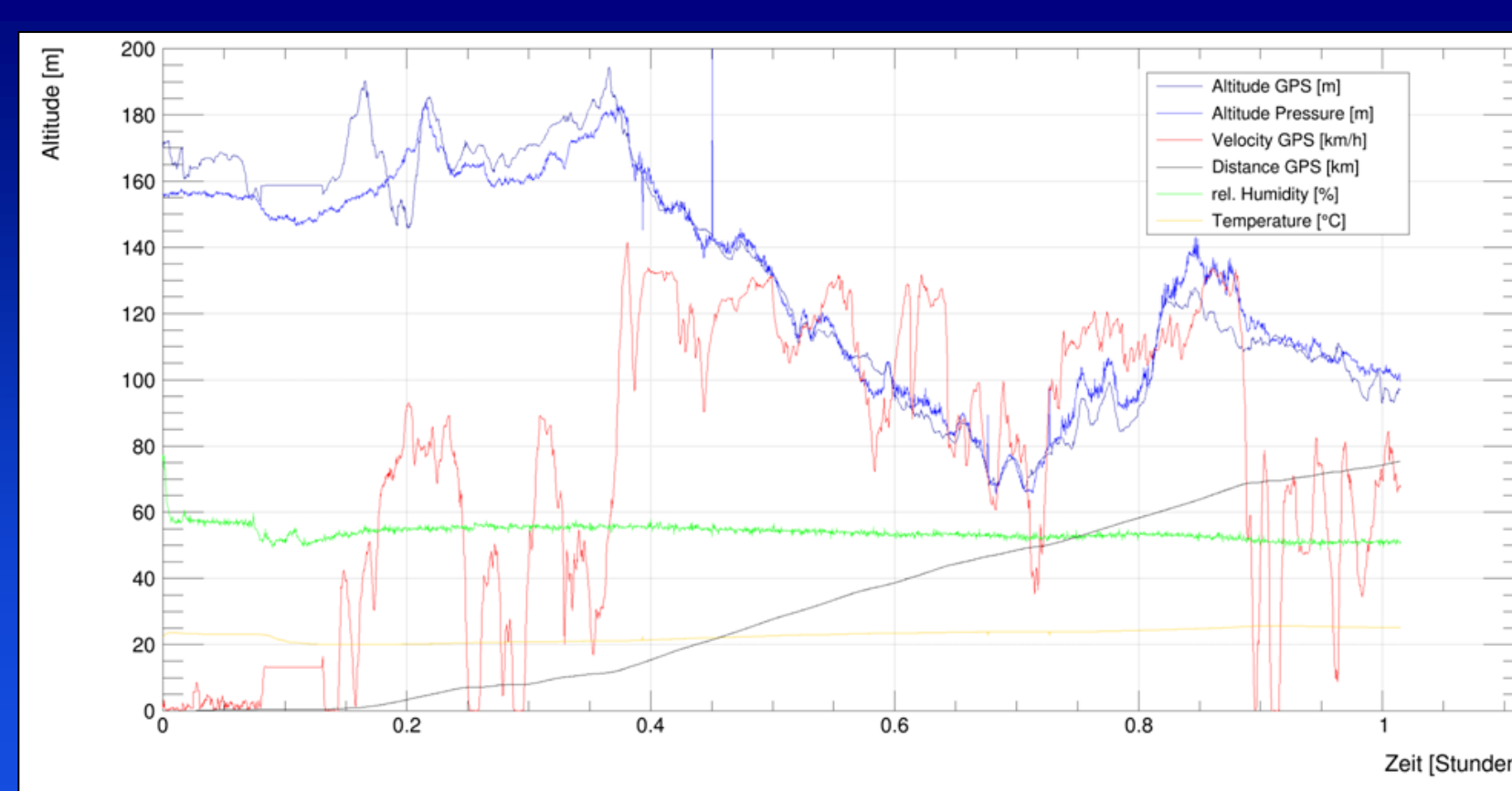
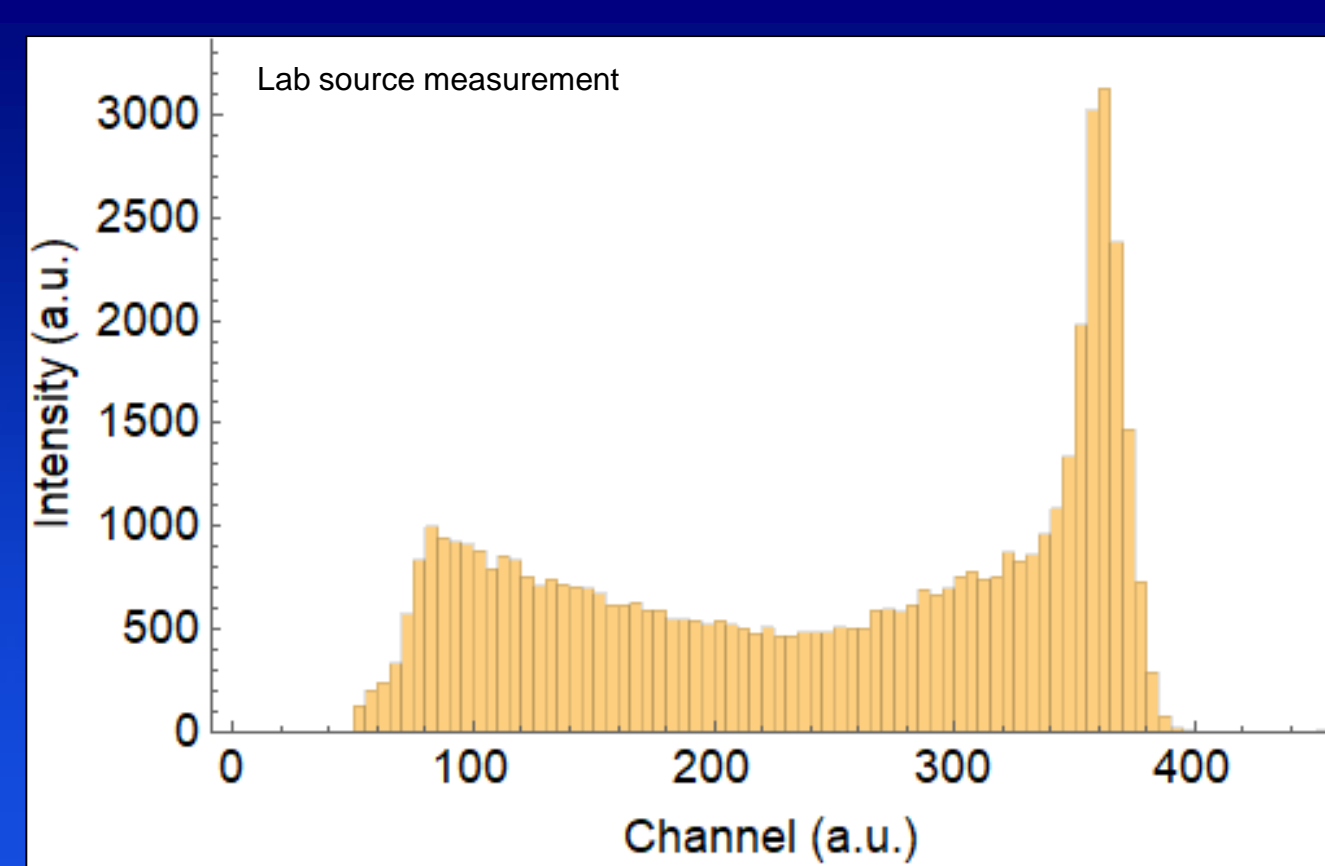
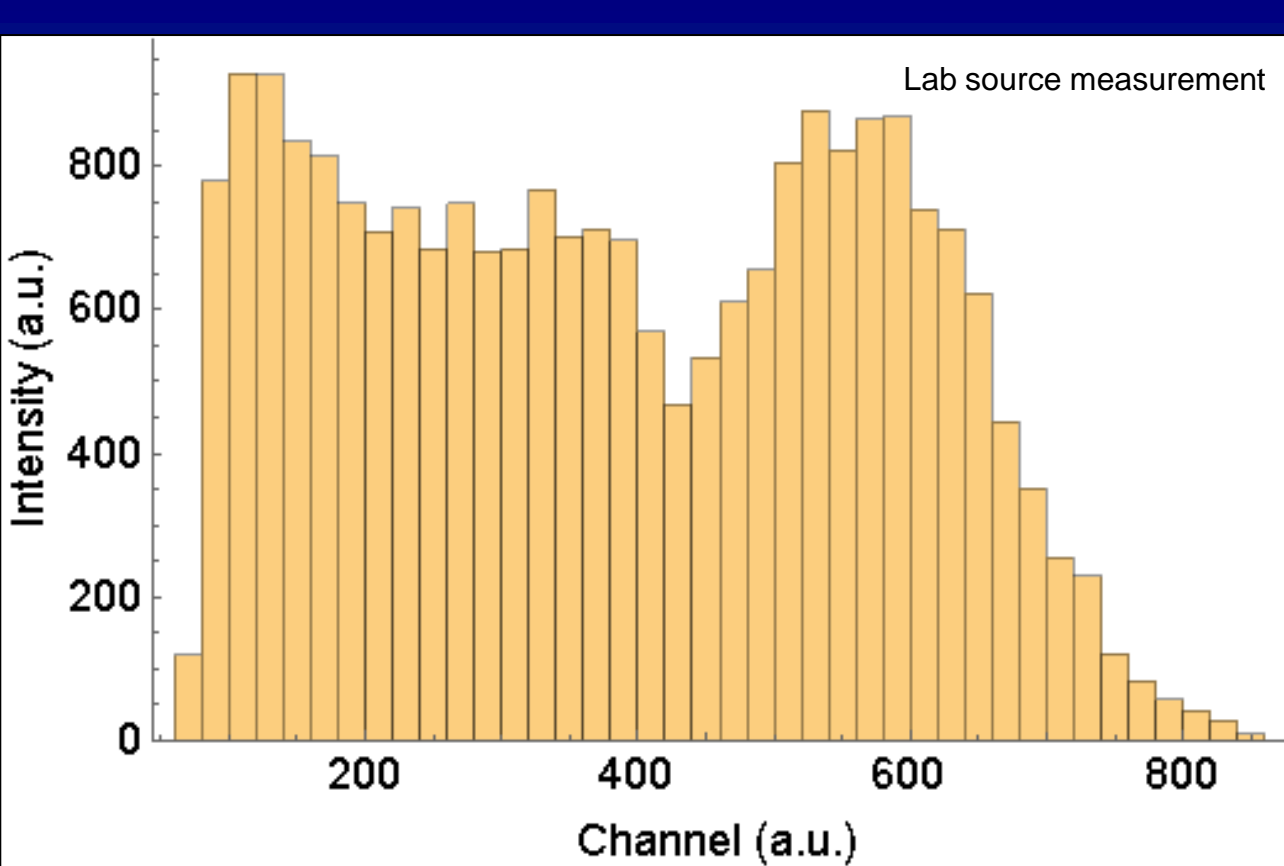
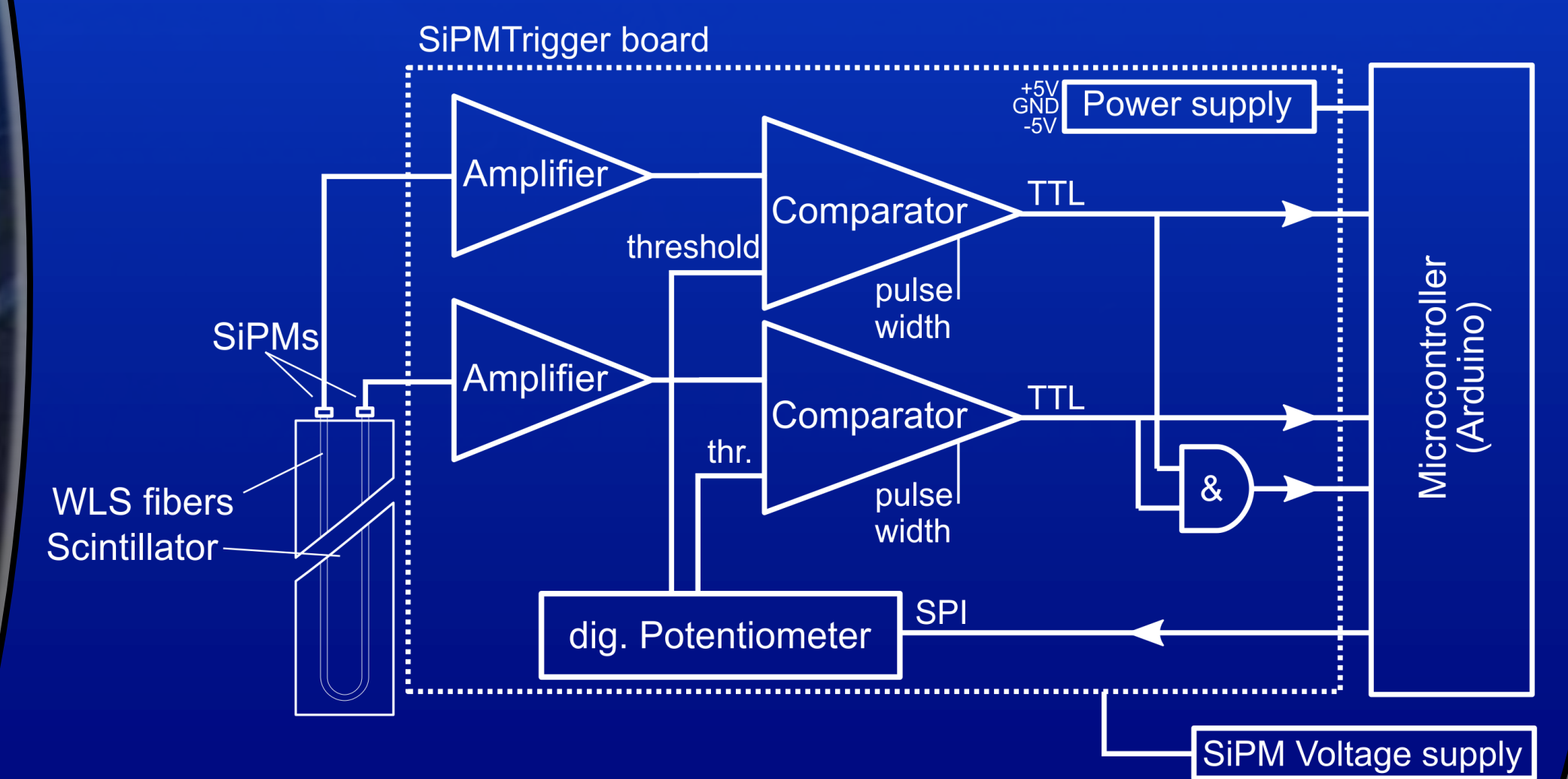
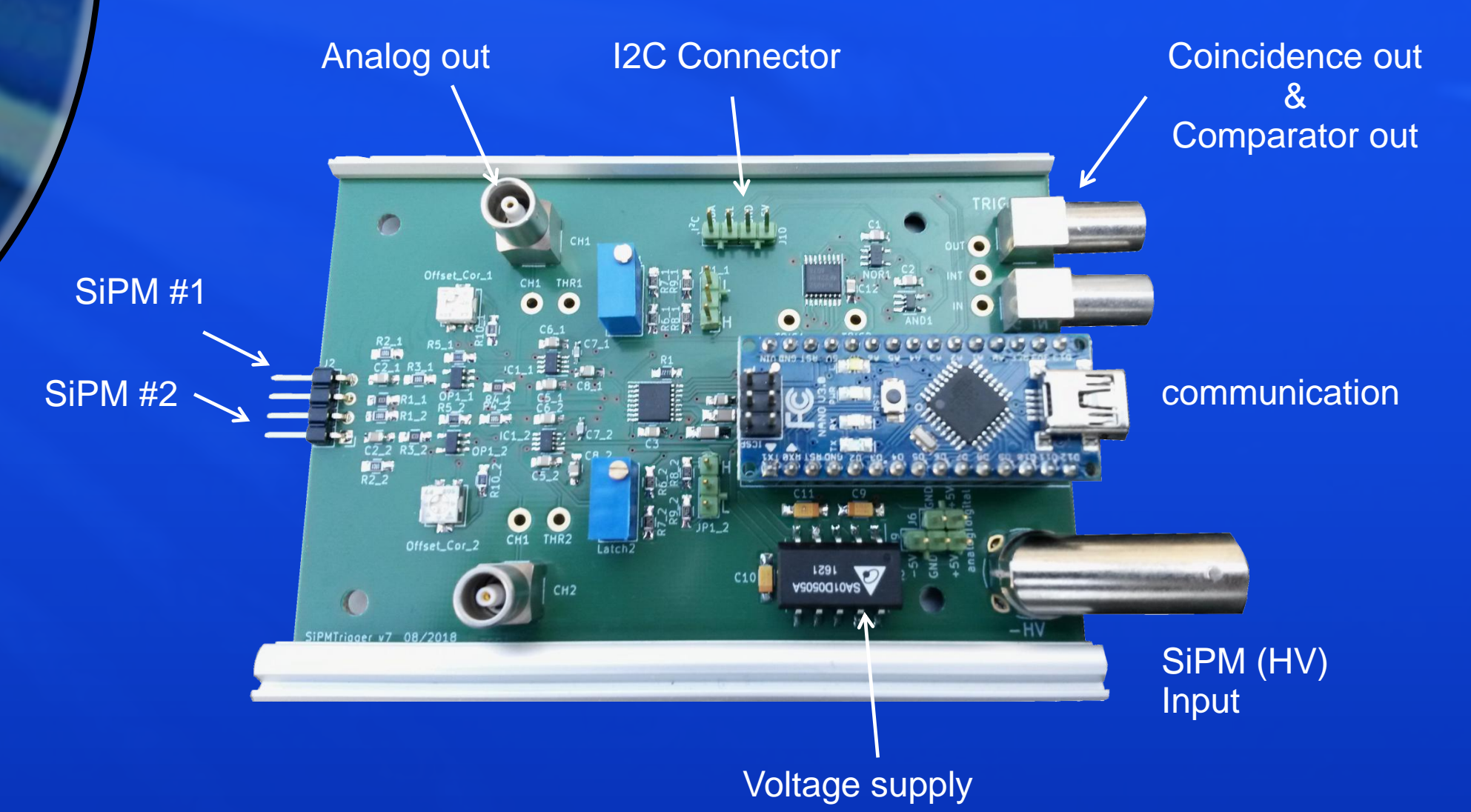

Data Taking Showcase

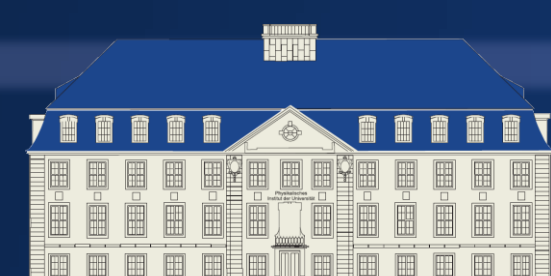

Jochen Kaminski (kaminski@physik.uni-bonn.de)
Physikalisches Institut, Universität Bonn
Nussallee 12, 53115 Bonn, Germany

Ulrich Schmidt (ulrich.schmidt@physi.uni-heidelberg.de)
Physikalisches Institut, Universität Heidelberg
Im Neuenheimer Feld 226, 69120 Heidelberg, Germany



Bundesministerium für Bildung und Forschung