

Accelerator Physics

Lecture 8

Longitudinal Beam Dynamics

- HF-Synchronisation
- Separatrix
- Buncher

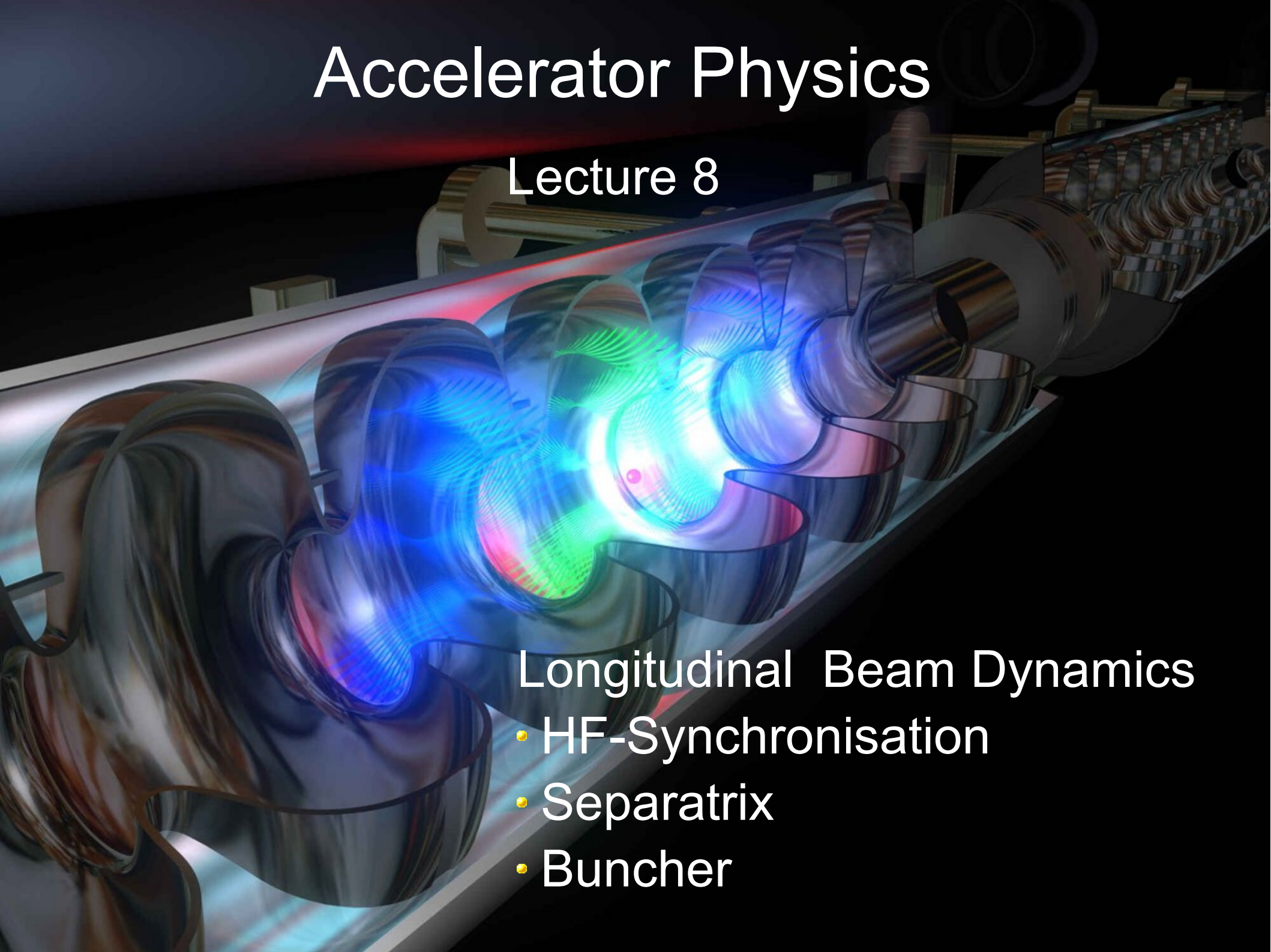

Stable Region of HF-Acceleration

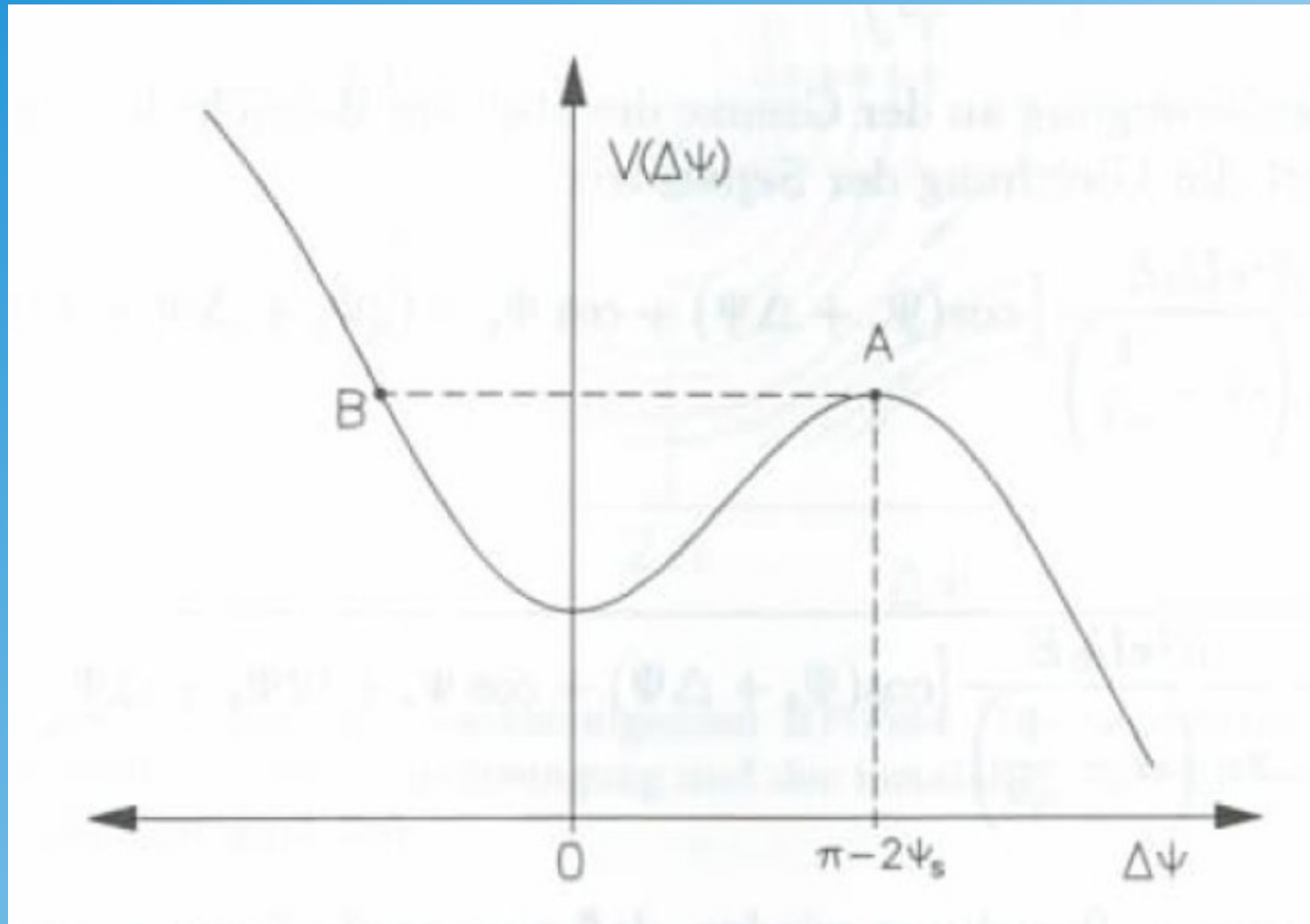

Separatrix and Nominal Phase

equilibrium (nominal) point

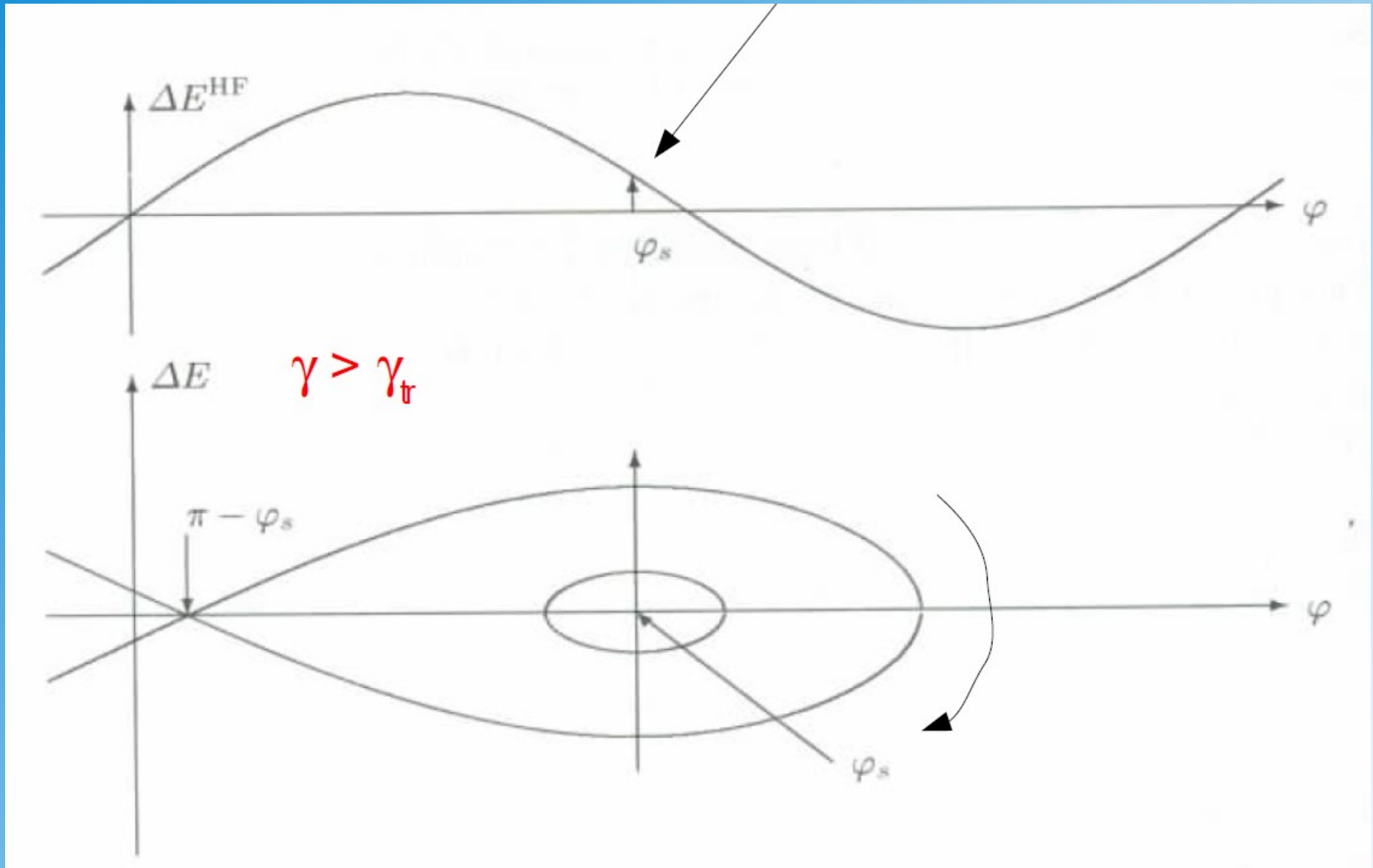

Separatrix and Nominal Phase

equilibrium (nominal) point

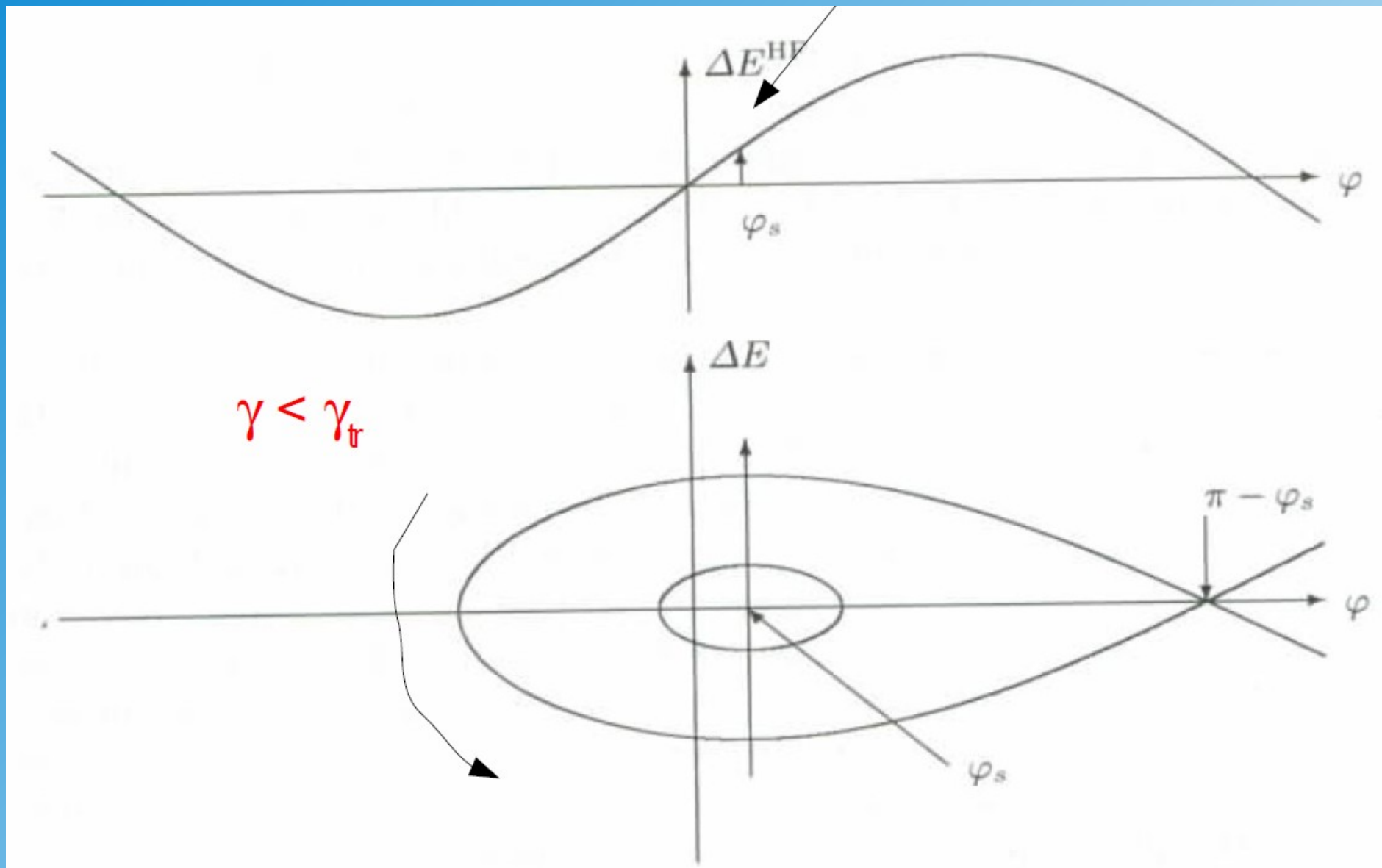

Bucket Structures

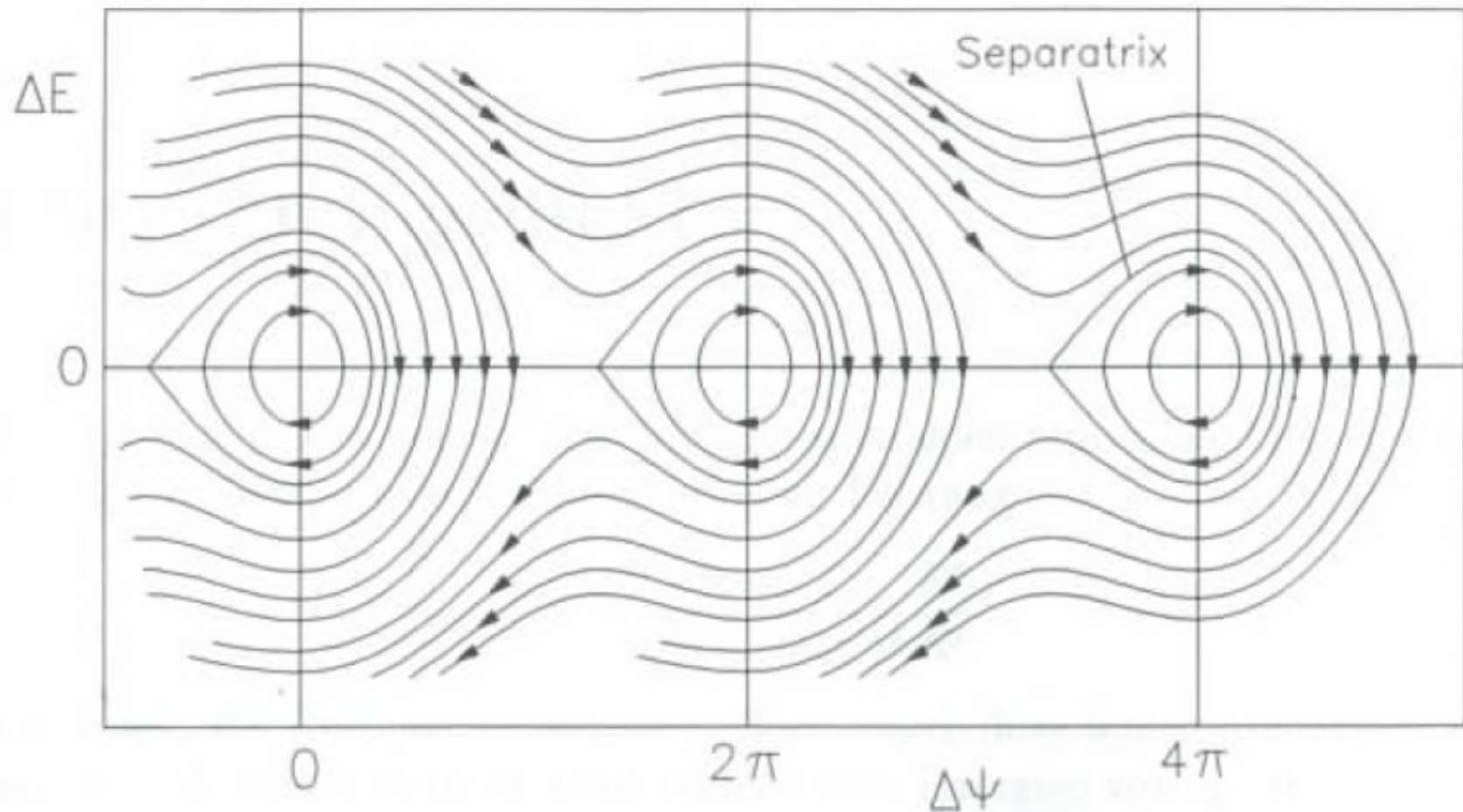
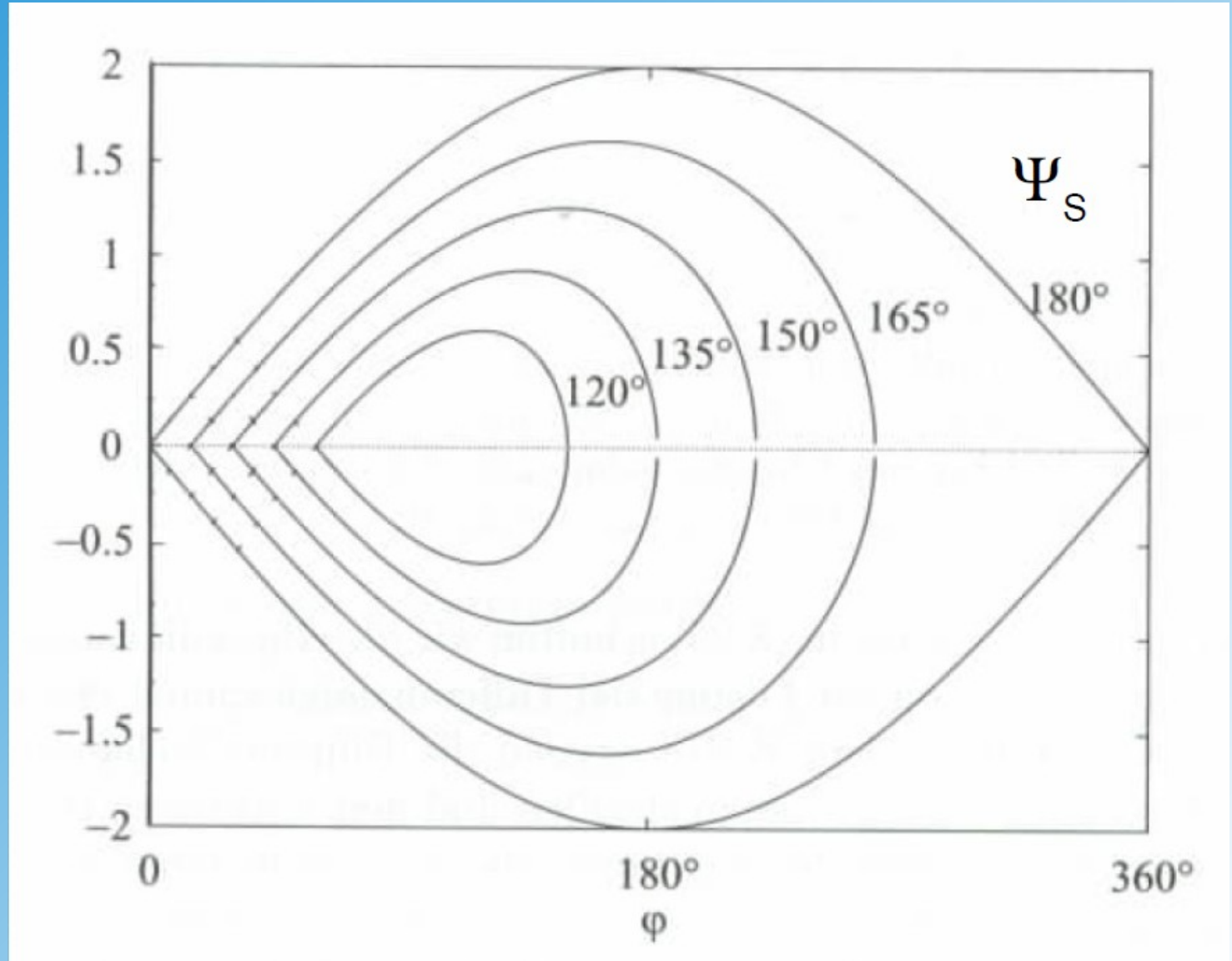

Fig. 5.17 Teilchenbewegung im beschleunigenden HF-Feld. Die Separatrix legt die Grenze zwischen der stabilen Synchrotronschwingung und der instabilen, für die Beschleunigung ungeeigneten Teilchenbewegung fest.

Bucket and Separatrix

$$\Delta E \sim (d\Psi/dt) / \omega_{\text{syn}}$$



FODO element

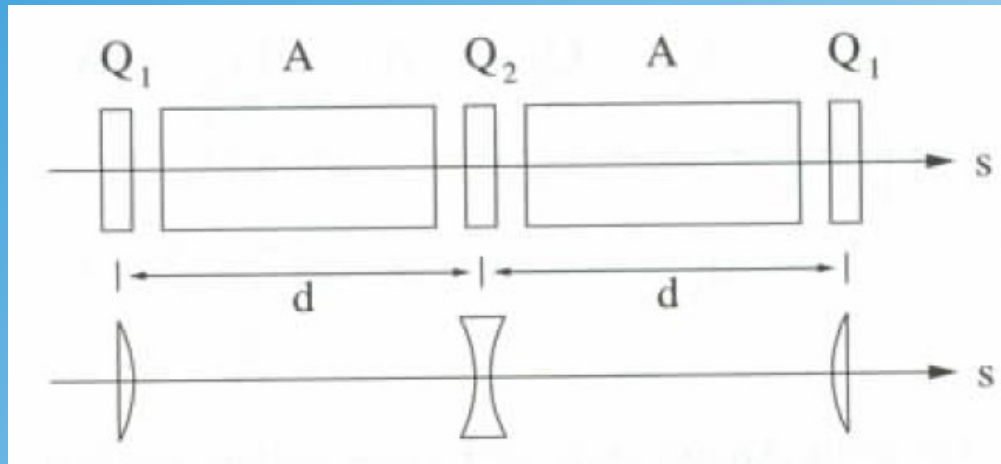

Buncher ($v \ll c$)

